

## Burner control units BCU 580

Technical Information · GB  
6 Edition 11.15l

- For monitoring and controlling modulating or staged burners for multiple burner applications with a central air supply
- For directly ignited burners or burners ignited by a pilot burner in intermittent or continuous operation
- Optionally with valve proving system
- PROFINET fieldbus connection using optional bus module



# Contents

<b>Burner control units BCU 580</b> .....	<b>1</b>	5.2 Proof of closure function .....	36
<b>Contents</b> .....	<b>2</b>	5.2.1 Program sequence .....	36
<b>1 Application</b> .....	<b>5</b>	<b>6 BCSoft</b> .....	<b>37</b>
1.1 Examples of application .....	9	<b>7 Profinet</b> .....	<b>38</b>
1.1.1 Stage-controlled main burner with alternating pilot burner .....	9	7.1 BCU and bus module BCM .....	39
1.1.2 Stage-controlled main burner with permanent pilot burner .....	10	7.2 GSD file for PLC configuration .....	41
1.1.3 Two-stage-controlled main burner with permanent pilot burner .....	11	7.2.1 Modules for cyclic data exchange .....	42
1.1.4 Modulating-controlled burner .....	12	7.2.2 Indexes for acyclic communication .....	48
1.1.5 Flame control using the temperature .....	13	<b>8 Program step/status</b> .....	<b>49</b>
1.1.6 PROFINET connection using bus module BCM .....	14	<b>9 Fault signalling</b> .....	<b>51</b>
1.1.7 ON/OFF rotary impulse control .....	15	<b>10 Parameters</b> .....	<b>54</b>
1.1.8 Modulating burner control .....	17	10.1 Scanning the parameters .....	58
<b>2 Certification</b> .....	<b>18</b>	10.2 Flame control .....	58
<b>3 Function</b> .....	<b>19</b>	10.2.1 Switch-off threshold of the flame amplifier .....	58
3.1 Connection diagram .....	19	10.2.2 Flame control .....	59
3.1.1 BCU 580..F1 with ionization control in single-electrode operation .....	19	10.2.3 High temperature operation .....	60
3.1.2 BCU 580..F2 .....	20	10.3 Behaviour during start-up .....	63
3.1.3 BCU 580..F3 .....	21	10.3.1 Burner 1 start-up attempts .....	63
3.1.4 Flame control .....	22	10.3.2 Burner 2 start-up attempts .....	64
3.2 BCU 580 program sequence .....	23	10.3.3 Burner application .....	65
<b>4 Air control</b> .....	<b>25</b>	10.3.4 Safety time 1 $t_{SA1}$ .....	68
4.1 Capacity control .....	26	10.3.5 Flame proving period 1 $t_{FS1}$ .....	68
4.1.1 BCU..F1/F2 .....	26	10.3.6 Safety time 2 $t_{SA2}$ .....	69
4.1.2 BCU..F3 .....	28	10.3.7 Flame proving period 2 $t_{FS2}$ .....	69
<b>5 Valve proving system</b> .....	<b>29</b>	10.4 Behaviour during operation .....	70
5.1 Tightness test .....	29	10.4.1 Restart .....	70
5.1.1 Test instant .....	30	10.4.2 Minimum operating time $t_B$ .....	73
5.1.2 Program sequence .....	31	10.4.3 Pilot burner .....	73
5.1.3 Test period $t_P$ .....	33	10.5 Safety limits .....	74
5.1.4 Opening time $t_L$ .....	33	10.5.1 Safety time during operation .....	74
5.1.5 Measurement time $t_M$ .....	33	10.6 Air control .....	75
		10.6.1 Capacity control .....	75
		10.6.2 Running time selection .....	84
		10.6.3 Running time .....	84
		10.6.4 Low fire over-run .....	85

10.6.5 Controller enable signal delay time $t_{RF}$ .....	86	12.6 Protecting the pilot burner from overload .....	109
10.6.6 Air actuator control .....	86	12.7 Calculating the safety time $t_{SA}$ .....	110
10.6.7 Air actuator can be activated externally on start-up .....	89	12.8 Fifth or switchable gas valve on BCU..F3 .....	111
10.6.8 Air actuator in the event of fault .....	89	<b>13 Accessories .....</b>	<b>112</b>
10.6.9 Capacity control (bus) .....	90	13.1 BCSoft .....	112
10.7 Valve check .....	95	13.1.1 Opto-adapter PCO 200 .....	112
10.7.1 Valve proving system .....	95	13.1.2 Bluetooth adapter PCO 300 .....	112
10.7.2 Relief valve (VPS) .....	96	13.2 OCU .....	112
10.7.3 Measurement time $V_{p1}$ .....	96	13.3 Connection plug set .....	113
10.7.4 Valve opening time 1 $t_{L1}$ .....	97	13.4 Stickers for labelling .....	113
10.8 Behaviour during start-up .....	98	13.5 "Changed parameters" stickers .....	113
10.8.1 Minimum pause time $t_{BP}$ .....	98	<b>14 OCU .....</b>	<b>114</b>
10.9 Manual mode .....	99	14.1 Application .....	114
10.9.1 Operating time in Manual mode .....	99	14.2 Function .....	115
10.10 Functions of terminals 50, 51, 65, 66, 67 and 68 .....	100	14.2.1 Manual mode .....	116
10.10.1 Function of terminal 50 .....	100	14.3 Electrical connection .....	117
10.10.2 Function of terminal 51 .....	100	14.4 Installation .....	117
10.10.3 Function of terminal 65 .....	100	14.5 Selection .....	118
10.10.4 Function of terminal 66 .....	101	14.6 Technical data for OCU .....	118
10.10.5 Function of terminal 67 .....	101	<b>15 BCM 500 .....</b>	<b>119</b>
10.10.6 Function of terminal 68 .....	101	15.1 Application .....	119
10.11 Password .....	102	15.2 Function .....	119
10.12 Fieldbus communication .....	102	15.3 Electrical connection .....	119
<b>11 Selection .....</b>	<b>103</b>	15.4 Installation .....	120
11.1 Type code .....	103	15.5 Selection .....	120
<b>12 Project planning information .....</b>	<b>104</b>	15.6 Technical data .....	120
12.1 Installation .....	104	<b>16 Technical data .....</b>	<b>121</b>
12.2 Commissioning .....	104	16.1 Electrical data .....	121
12.3 Electrical connection .....	105	16.2 Mechanical data .....	122
12.3.1 OCU .....	105	16.3 Environment .....	122
12.3.2 Safety current inputs .....	106	16.4 Dimensions .....	122
12.3.3 UVD control .....	107	16.5 Safety-specific characteristic values .....	123
12.4 Actuators .....	108	16.6 Converting units .....	124
12.4.1 IC 20 .....	108		
12.5 Parameter chip card .....	109		

<b>17 Maintenance</b> .....	<b>125</b>
<b>18 Legend</b> .....	<b>126</b>
<b>19 Glossary</b> .....	<b>127</b>
19.1 Waiting time $t_W$ .....	127
19.2 Ignition time $t_Z$ .....	127
19.3 Safety interlocks .....	127
19.4 Safety time on start-up $t_{SA1}$ .....	127
19.5 Safety time during operation $t_{SB}$ .....	127
19.6 Safety shut-down .....	128
19.7 Fault lock-out .....	128
19.8 Warning signal .....	128
19.9 Timeout .....	128
19.10 Lifting .....	129
19.11 Air valve .....	129
19.12 Diagnostic coverage DC .....	129
19.13 Operating mode .....	129
19.14 Safe failure fraction SFF .....	130
19.15 Probability of dangerous failure $PFH_D$ .....	130
19.16 Mean time to dangerous failure $MTTF_d$ .....	130
<b>Feedback</b> .....	<b>131</b>
<b>Contact</b> .....	<b>131</b>

### 1 Application



*Burner control unit with plug-in spring force connection terminals*

Burner control unit BCU 580 controls, ignites and monitors gas burners in intermittent or continuous operation. It can be used for gas burners of unlimited capacity which are ignited by pilot burners. The burners may be modulating-controlled or stage-controlled. Its fast reaction to various process requirements makes the BCU suitable for frequent cycling operation.

On industrial furnaces, it reduces the load on the central furnace control by taking over tasks that relate to the burner, for example it ensures that the burner ignites in a safe condition when it is restarted.

The air control on the BCU..F1, F2 or F3 assists the furnace control for cooling, purging and capacity control tasks.

The burner control unit has an interface via which an air valve or actuator (IC 20, IC 40 or RBW) can be controlled for staged or modulating burner capacity control.

The program status, the unit parameters and the level of the flame signal can be read directly from the unit. The burners or a connected control element can be activated manually using the integrated Manual mode for setting and diagnostic purposes.

Thanks to the optionally integrated valve proving system, the valves can be checked for leaks by querying an external gas pressure switch or it can be checked whether the gas valve on the inlet side is closed.

## Application

Using the BCSoft program, the parameters, analysis and diagnostic information can be read from a BCU via the optionally available opto-adapter. All valid parameters are saved on an integrated parameter chip card. The parameter chip card can be removed from the old unit and inserted into a new BCU to transfer the parameters, for example when replacing the unit.

The monitored outputs for the actuator and valves are accommodated in a plug-in power module. This can simply be replaced if necessary.



*Once the plug-in power module has been removed, the parameter chip card and fuses are accessible.*

The BCU can be installed on a DIN rail in the control cabinet. Plug-in connection terminal strips on the BCU make it easier to install and remove.



*Thanks to the operator-control unit OCU, display functions and operation of the BCU can be relocated to the control cabinet door.*

## Application

---

The external operator-control unit OCU is available as an option for the burner control units. The OCU can be installed in the control cabinet door instead of standard control units. The program status, flame signal or fault messages can be read on the OCU. For burner adjustment, the operating points can be approached conveniently in Manual mode using the operator-control unit.



*The address for the fieldbus communication is set using three code switches.*

The optional bus module BCM 500 makes it possible to connect the BCU to a PROFINET network via a fieldbus interface. Networking via the fieldbus enables multiple BCUs to be controlled and monitored by an automation system (e.g. PLC). The bus module is prepared for DIN rail installation. It is pushed on to the BCU from the side.



*Bogie hearth forging furnace in the metallurgical industry*



*Intermittent shuttle kiln in the ceramics industry*



*Walking beam furnace with overhead firing*



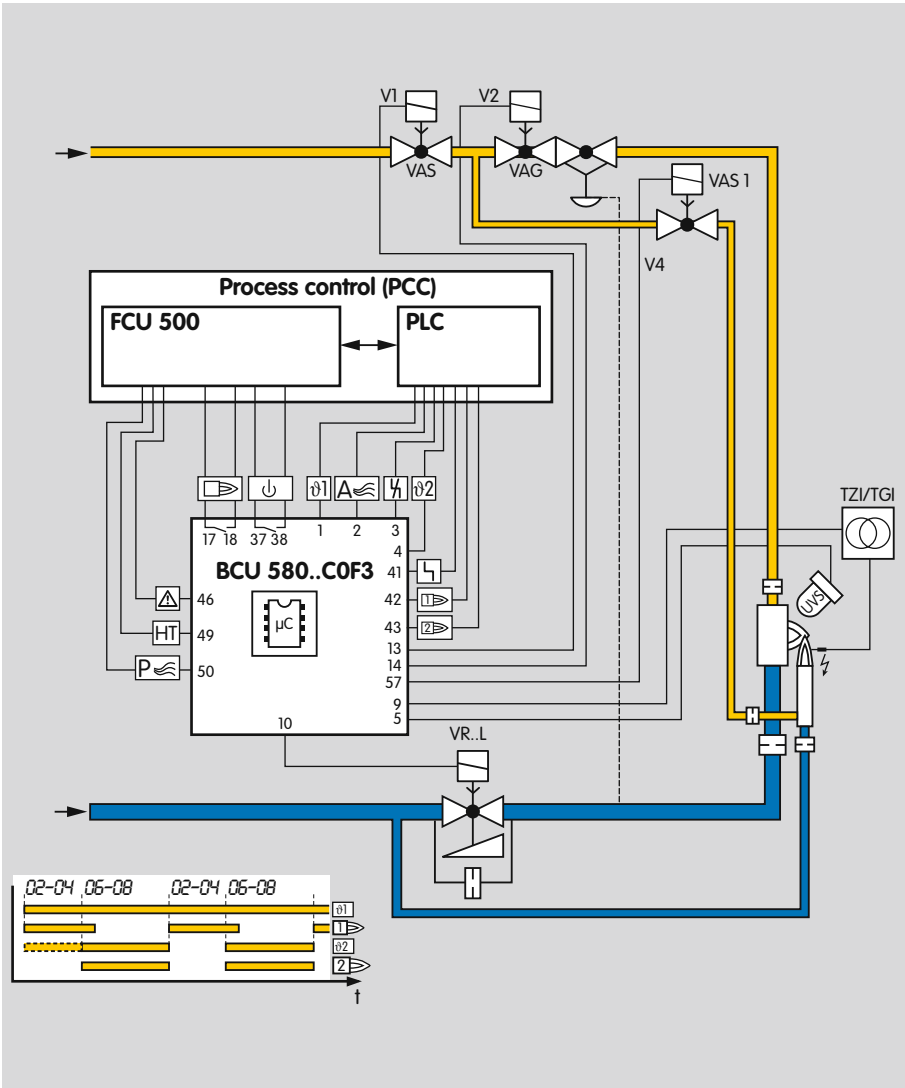

## 1.1 Examples of application

### 1.1.1 Stage-controlled main burner with alternating pilot burner

Control:

Main burner ON/OFF or High/Low

The main burner can be started with reduced capacity after the operating signal from the pilot burner has been detected. The pilot burner is switched off automatically after the main burner has started up. When the main burner is switched off, the pilot burner automatically switches on again. This reduces the main burner start-up time.

The UV sensor monitors the flame signal from pilot and main burners. The BCU provides the cooling and purging processes.

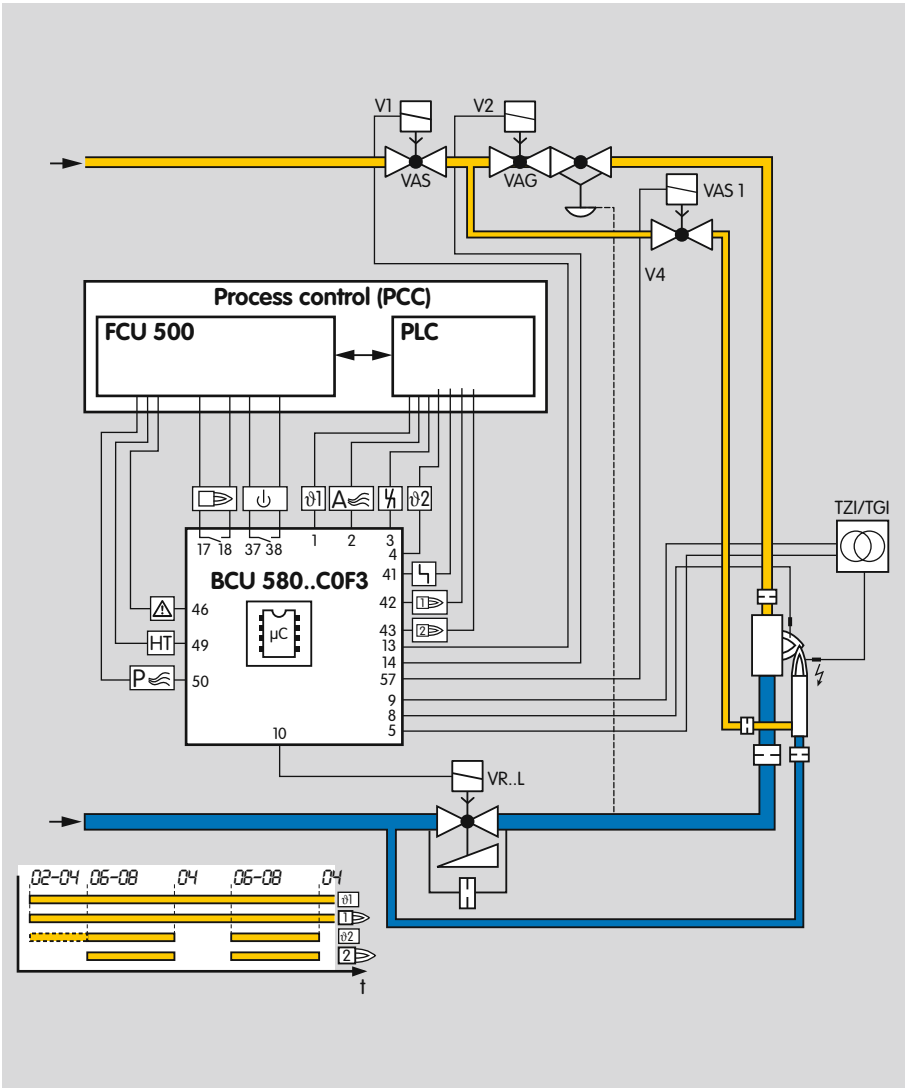

### 1.1.2 Stage-controlled main burner with permanent pilot burner

Control:

Main burner ON/OFF or High/Low

The main burner can be started with reduced capacity after the operating signal from the pilot burner has been detected. Pilot and main burners can be operated simultaneously. This reduces the time required by the main burner for starting up.

The BCU provides the cooling and purging processes.

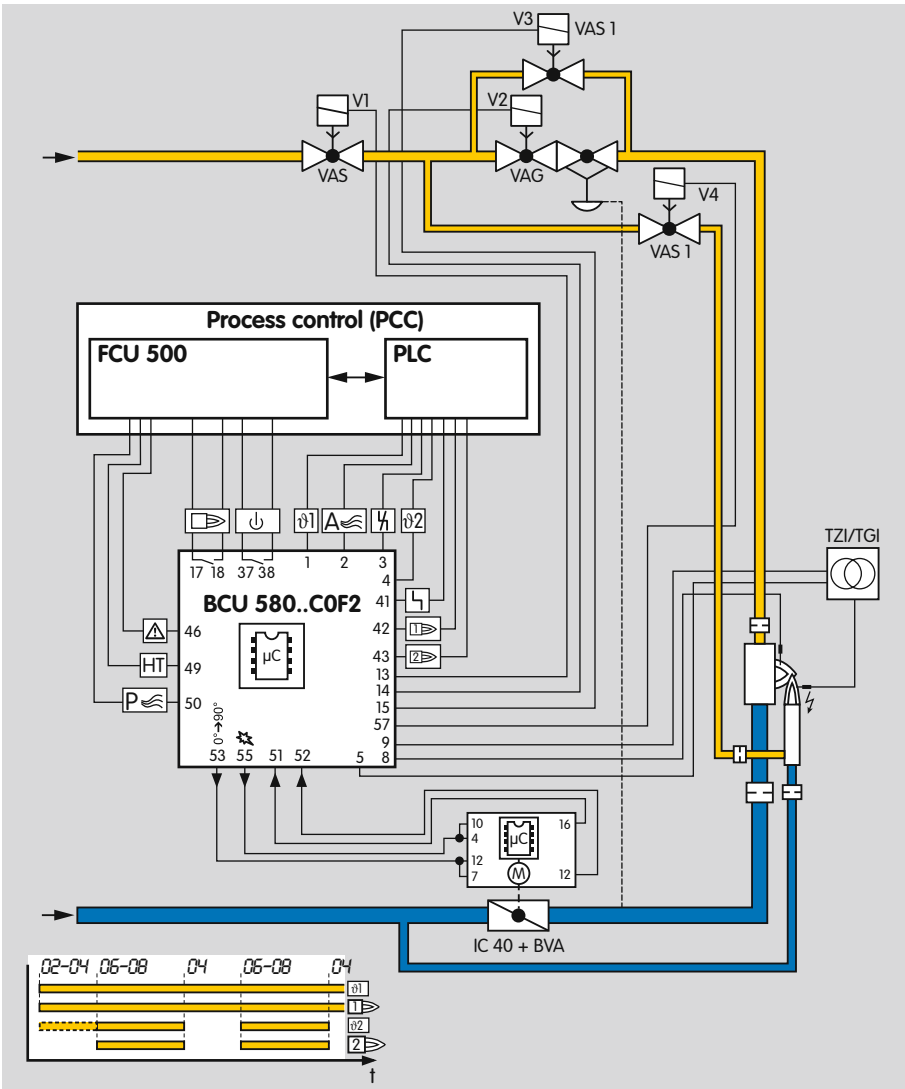

### 1.1.3 Two-stage-controlled main burner with permanent pilot burner

Control:

Main burner ON/OFF with ignition via bypass

The main burner can be started with minimum capacity after the operating signal from the pilot burner has been detected. When the operating state is reached, the BCU issues the Enable signal for the maximum burner capacity. Pilot and main burners can be operated simultaneously. This reduces the time required by the main burner for starting up.

The BCU provides the cooling and purging processes.

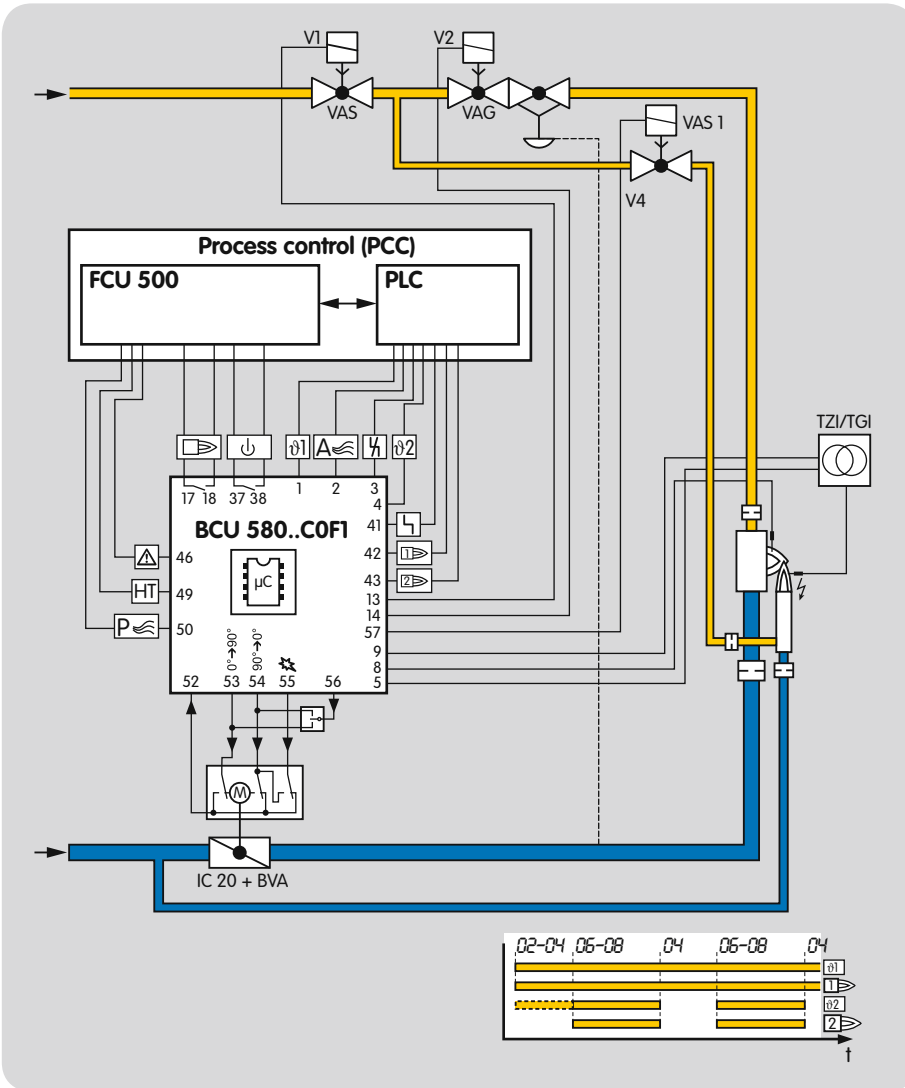

### 1.1.4 Modulating-controlled burner

Control:

Main burner continuous

The butterfly valve for air is moved to the position for minimum capacity in order to start the main burner. The main burner is started with minimum capacity after the operating signal from the pilot burner has been detected. The control system controls the burner capacity via the butterfly valve for air after the operating state has been signalled. Pilot and main burners can be operated simultaneously. This reduces the time required by the main burner for starting up.

### 1.1.5 Flame control using the temperature

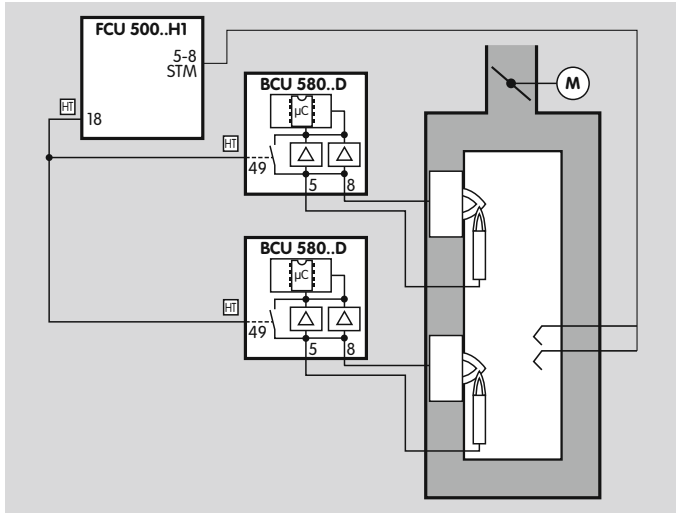

In high temperature systems (temperature  $> 750^{\circ}\text{C}$ ), the flame may be controlled indirectly via the temperature.

As long as the temperature in the furnace chamber is below  $750^{\circ}\text{C}$ , the flame must be controlled by conventional methods.

If the temperature in the furnace chamber rises above the spontaneous ignition temperature of the gas/air mixture ( $> 750^{\circ}\text{C}$ ), the FCU signals to the downstream burner control units via the fail-safe HT output that the furnace system is in High temperature mode (HT). When the HT input is activated, the burner control units switch to High temperature mode. They operate with-

out evaluating the flame signal and their internal flame control is non-functional.

If the furnace temperature falls below the spontaneous ignition temperature ( $< 750^{\circ}\text{C}$ ), the FCU disconnects the HT output from the electrical power supply. As soon as the signal to the HT inputs of the burner control units is no longer present, the flame signals are once again monitored by a UV sensor or ionization electrode. In the event of a fault in a temperature monitoring component (e.g. sensor discontinuity, sensor short-circuit) or in the event of a mains failure, the flame control task is transferred to the burner control units.

### 1.1.6 PROFINET connection using bus module BCM

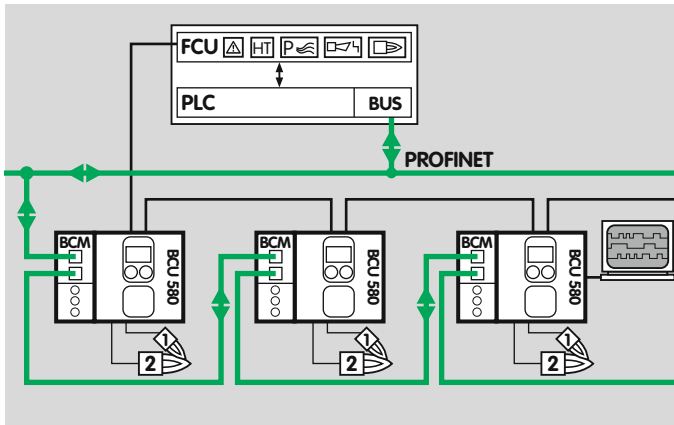

The bus system transfers the control signals from the automation system (PLC) to the BCU/BCM for starting, resetting, controlling the air valve, purging the furnace or for cooling and heating during operation. In the opposite direction, it sends operating status, the level of the flame signal and the current program status.

Control signals that are relevant for safety, such as the safety interlocks, purge and HT input, are transferred independently of the bus communication by separate cables.

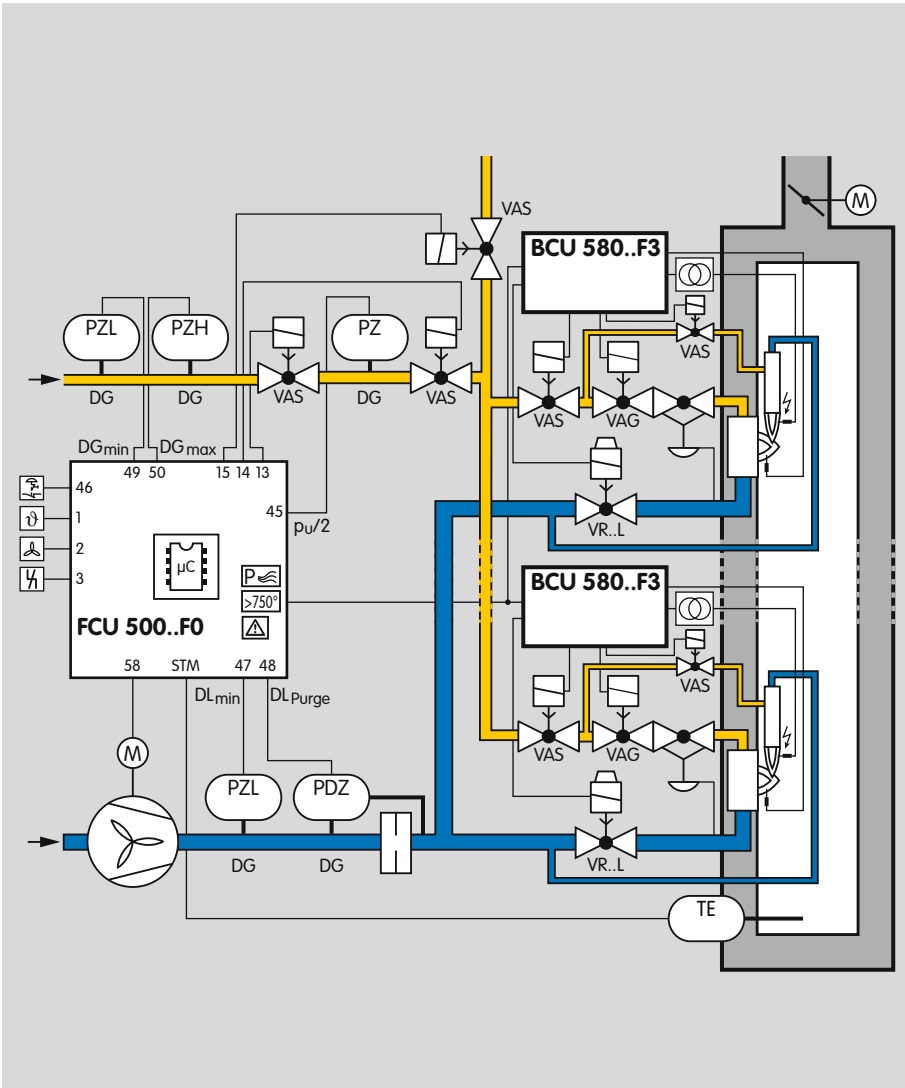

### 1.1.7 ON/OFF rotary impulse control

For processes which require a turn-down of more than 10:1 and/or those which require heavy circulation of the furnace atmosphere to ensure a uniform temperature, e.g. heat treatment furnaces operating at low and medium temperatures in the metallurgical industry.

With ON/OFF cyclic control, the capacity supplied to the process is controlled by means of a variable ratio of the operating time to the pause time. In this type of control, the burner output pulse frequency always maintains full momentum and results in maximum convection in the furnace chamber, even with regulated heating.

The pneumatic ratio control system controls the gas pressure on the burner proportionally to the air pressure and thus maintains a constant air/gas ratio. At the same time, it acts as a low air pressure protection device.

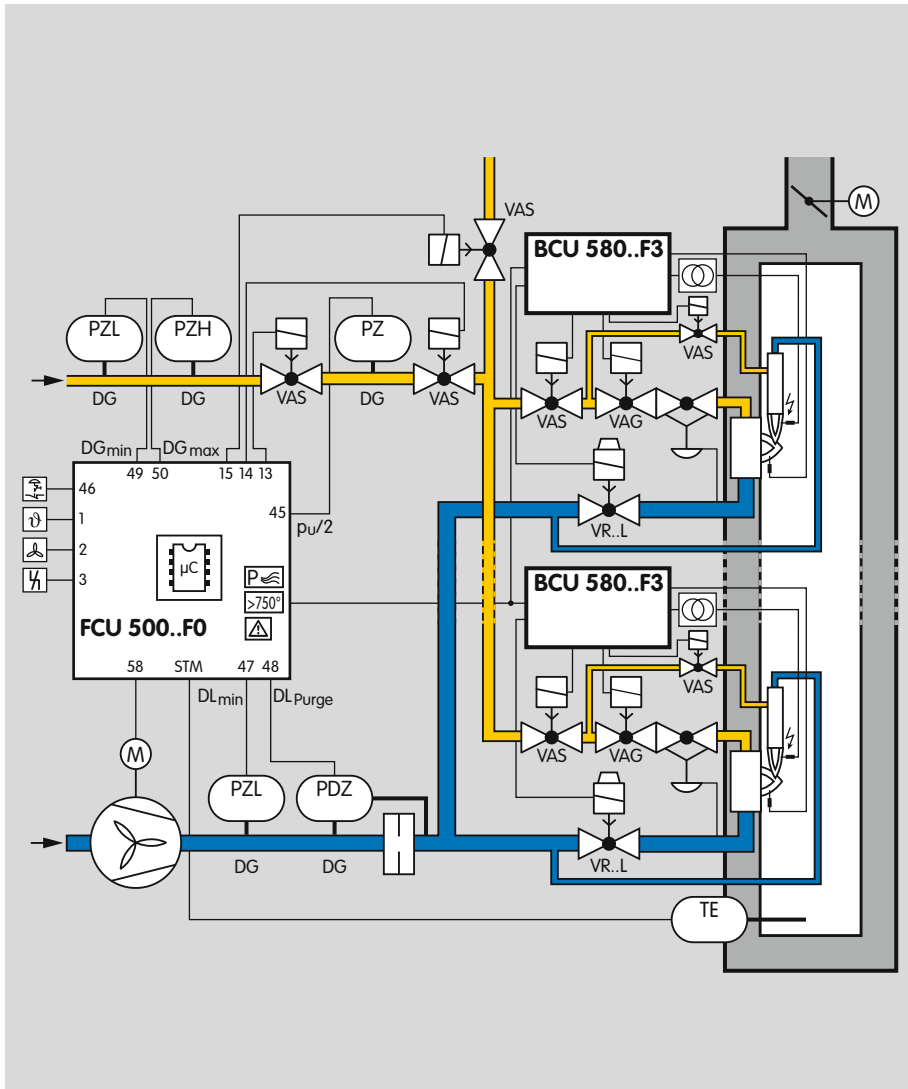

The ignition and monitoring of the pilot/main burners is ensured by burner control units BCU 580.

The centrally checked safety functions such as pre-purge, tightness test, flow detector and pressure switch check (gas<sub>min.</sub>, gas<sub>max.</sub>, air<sub>min.</sub>) are provided by the FCU 500.



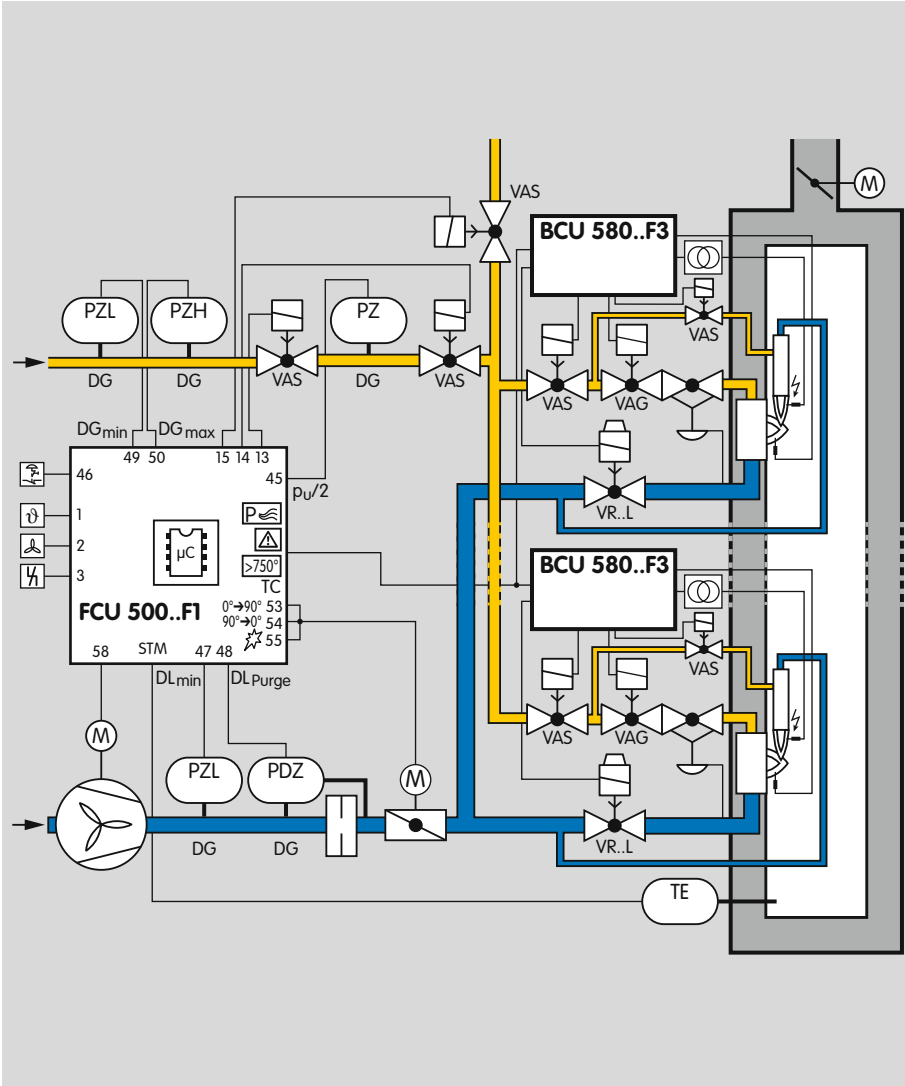

### 1.1.8 Modulating burner control

For processes that do not require heavy circulation in the furnace, e.g. aluminium smelting furnaces.

This system is suitable for processes in which infiltrated air may flow into the furnace through switched off burners. The capacity can be adjusted continuously by activating the air control valve (analogue or 3-point step signal).

The pneumatic ratio control system controls the gas pressure on the burner proportionally to the air pressure and thus maintains a constant air/gas ratio. At the same time, it acts as a low air pressure protection device.

The ignition and monitoring of the pilot/main burners is ensured by burner control units BCU 580.

The centrally checked safety functions such as pre-purge, tightness test, flow detector and pressure switch check (gas<sub>min.</sub>, gas<sub>max.</sub>, air<sub>min.</sub>) are provided by the FCU 500.

## 2 Certification

### Certified to SIL and PL



For systems up to SIL 3 pursuant to EN 61508 and PL e pursuant to ISO 13849

### EU certified pursuant to



- Gas Appliances Directive (2009/142/EC)

### Meets the requirements of the

- Low Voltage Directive (2006/95/EC),
- EMC Directive (2004/108/EC)

### FM approved



Factory Mutual Research Class: 7400 Process Control Valves. Designed for applications pursuant to NFPA 85 and NFPA 86. [www.approvalguide.com](http://www.approvalguide.com)

### ANSI/CSA approved



American National Standards Institute/Canadian Standards Association – ANSI Z21.20/CSA C22.2 No. 199

[www.csagroup.org](http://www.csagroup.org) – Class number: 3335-01 and 3335-81.

### Eurasian Customs Union



The product BCU 580 meets the technical specifications of the Eurasian Customs Union.

### 3 Function

#### 3.1 Connection diagram

##### 3.1.1 BCU 580..F1 with ionization control in single-electrode operation

Alternative flame control, see page 22 (Flame control).

Detailed connection diagrams for actuators and frequency converters, see from page 75 (Capacity control)

Electrical connection, see page 104 (Project planning information)

Explanation of symbols, see page 126 (Legend)

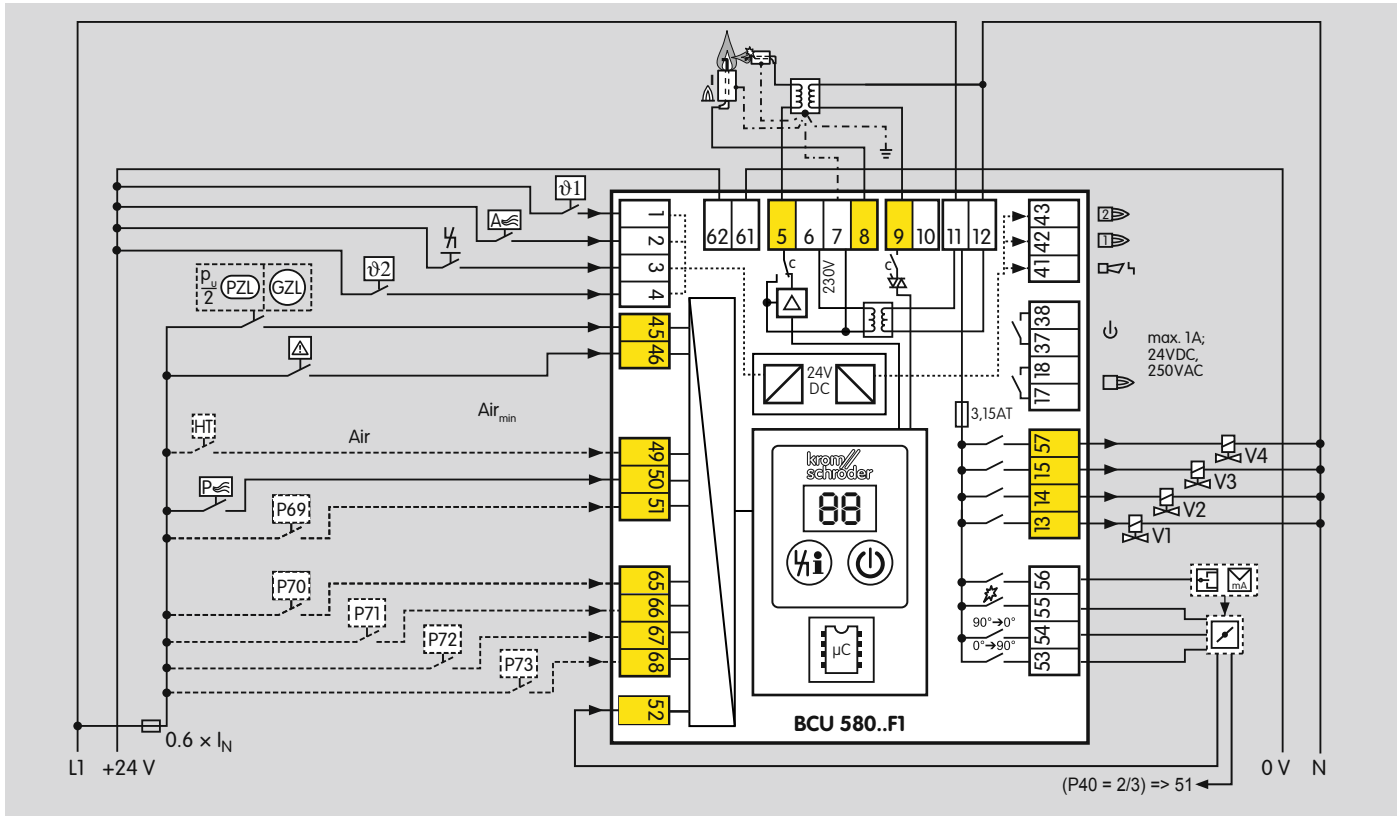

## Function

### 3.1.2 BCU 580..F2

Alternative flame control, see page 22 (Flame control).

Detailed connection diagrams for actuators and frequency converters, see from page 75 (Capacity control)

Electrical connection, see page 104 (Project planning information)

Explanation of symbols, see page 126 (Legend)

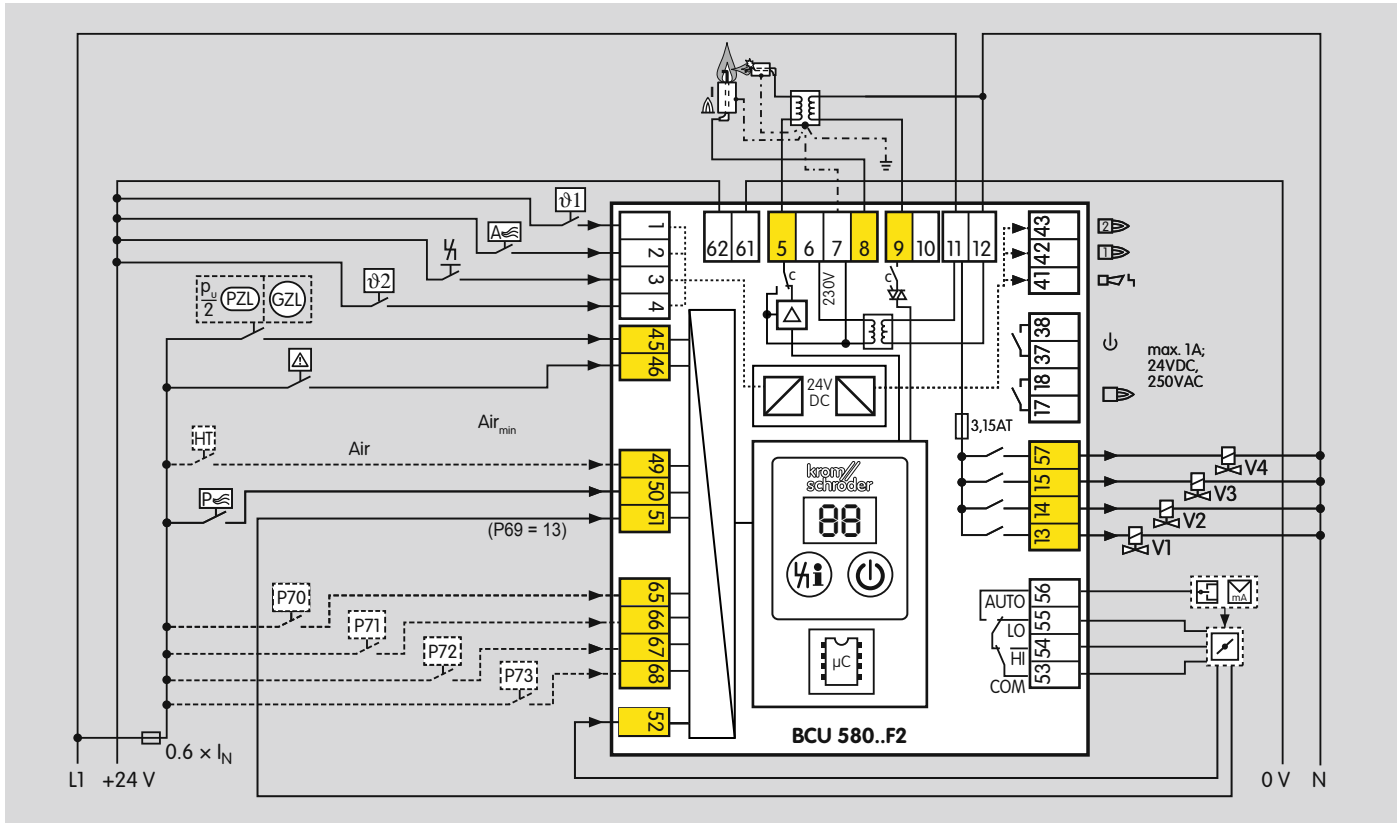

## Function

### 3.1.3 BCU 580..F3

Alternative flame control, see page 22 (Flame control).

Detailed connection diagrams for actuators, see from page 75 (Capacity control)

Electrical connection, see page 104 (Project planning information)

Explanation of symbols, see page 126 (Legend)

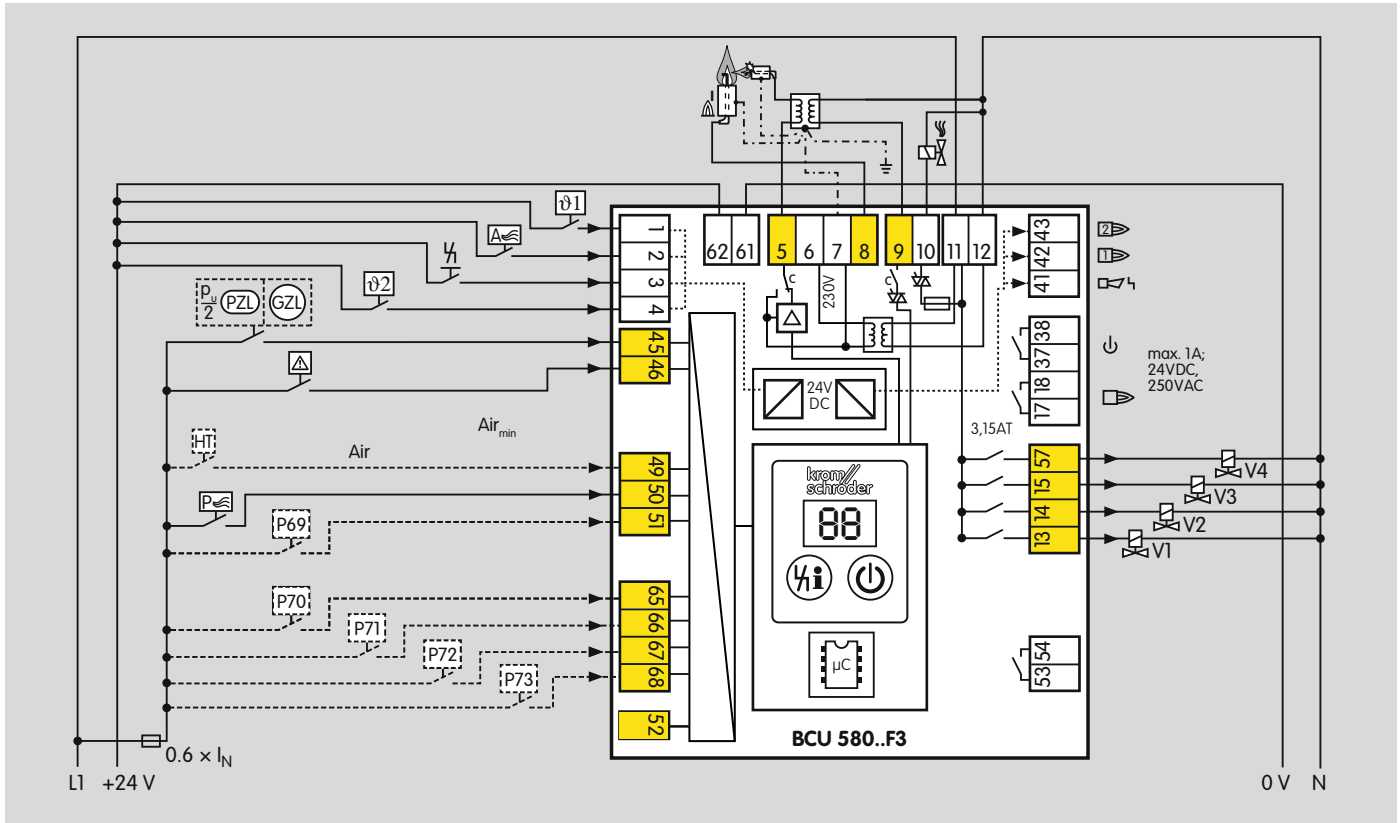

### 3.1.4 Flame control

#### Ionization control in double-electrode operation

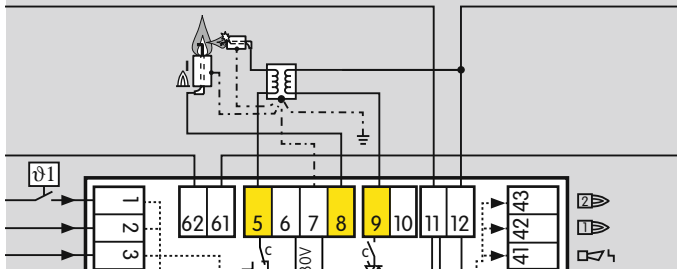

#### UVS control

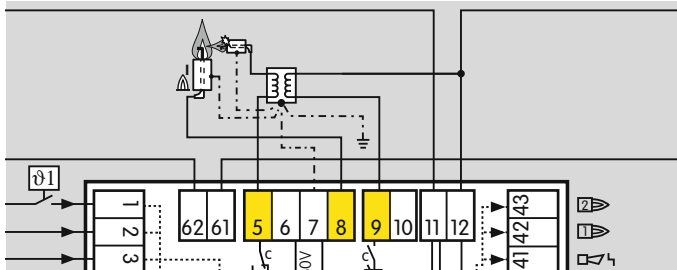

#### UVD control

A voltage supply of 24 V DC is required to operate the UV sensor for continuous operation UVD 1.

The 0 – 20 mA current output can be used to display the flame signal. The cable to the control room must be screened. The 0 – 20 mA current output is not required for normal operation.

Depending on Parameter 79, the following connection diagrams apply, see also page 73 (Pilot burner).

Alternating pilot burner (Parameter 79 = 0):

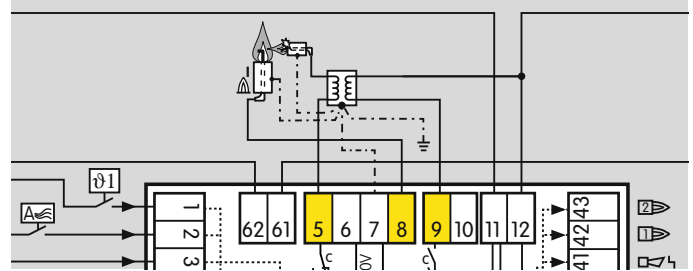

Permanent pilot burner (Parameter 79 = 1):

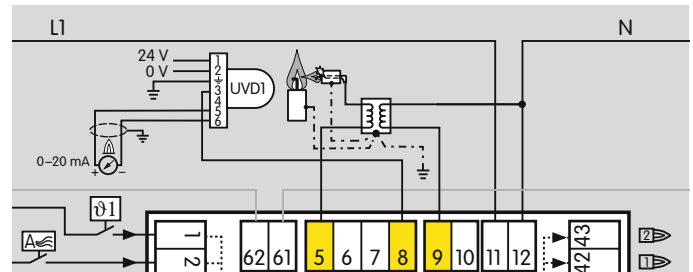

### 3.2 BCU 580 program sequence

Parameters 48 and 49 = 0: High/Low control during operation, cooling in standby

Example of application, see page 11 (Two-stage-controlled main burner with permanent pilot burner)

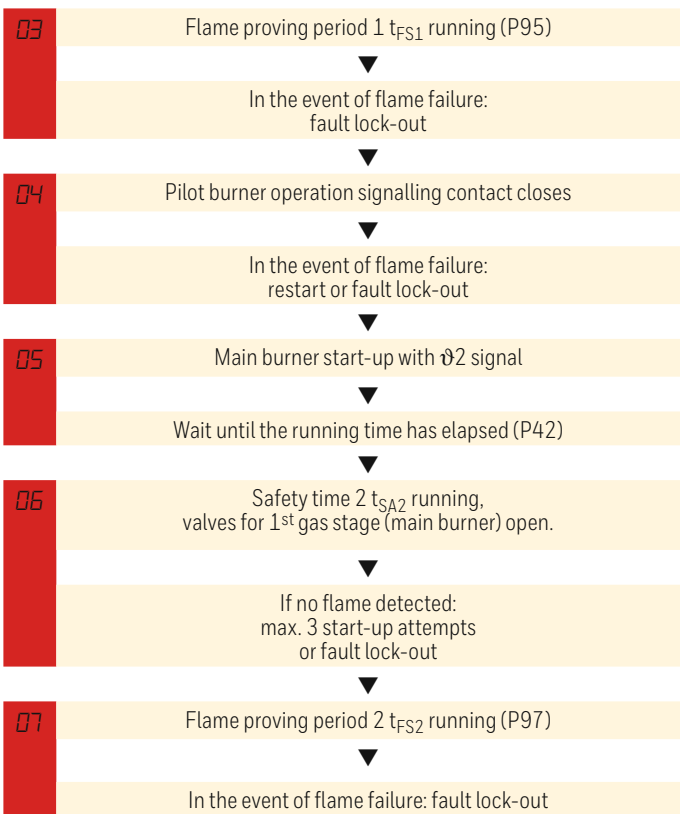
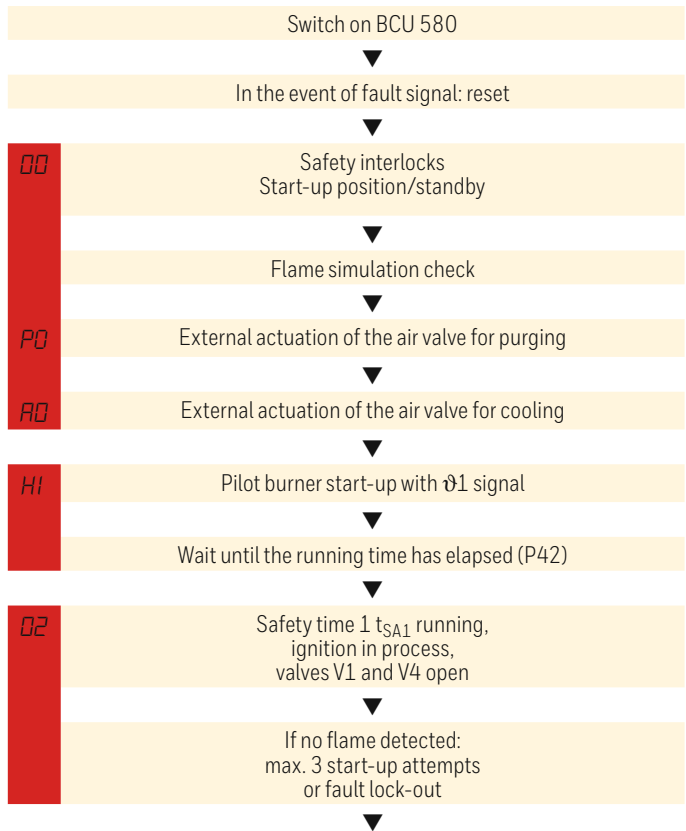

## Function

---

OB

Main burner operation signalling contact closes,  
minimum operating time  $t_B$  starts (P61)



In the event of flame failure:  
restart or fault lock-out



RB

External actuation of the air valve for capacity control

OB

Controlled shut-down via  $\varnothing$  signals for pilot and main burners



OB

If min. operating time  $t_B$  has elapsed:  
operation signalling contact opens,  
gas valves close and  
running time (P42) starts to elapse



## 4 Air control

A central protective system such as the FCU 500 takes over air control. It monitors the static air pressure as well as the air volume required for pre-purge, start-up and after the furnace has been shut down. The air actuators (BCU..F1 = actuators IC 20/40, BCU..F2 = RBW actuators, BCU..F3 = valve) are actuated for this purpose by the capacity control system of the BCU.

After being enabled by the protective system, the BCU can start the burners. The capacity is controlled during operation by an external temperature control system.

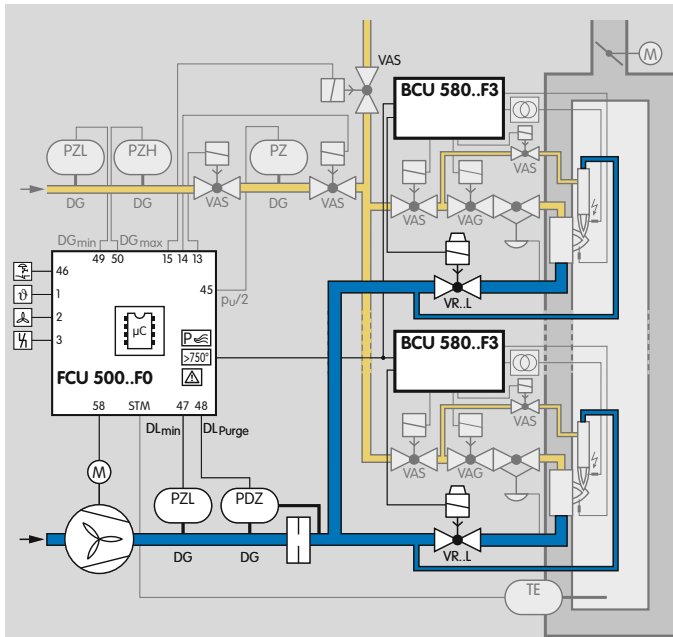

## 4.1 Capacity control

### 4.1.1 BCU..F1/F2

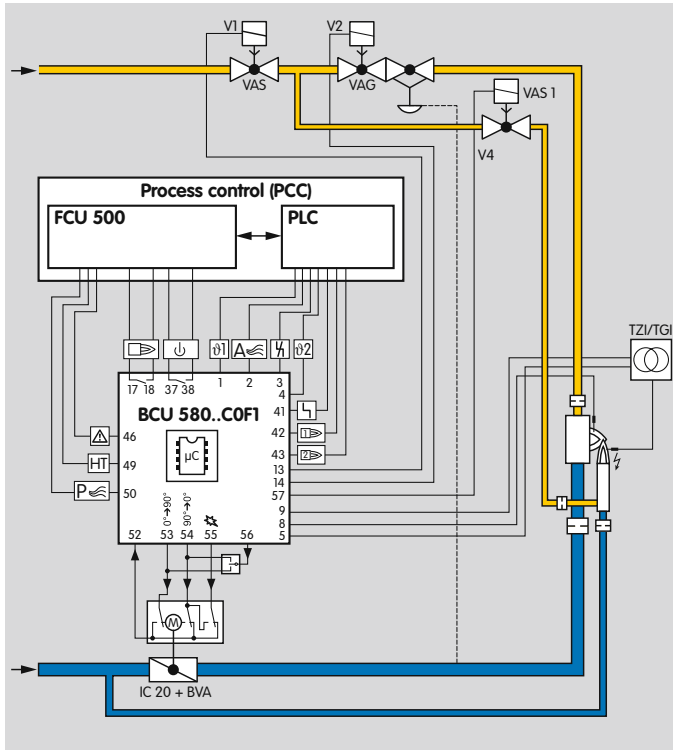

The BCU..F1/F2 activates a control element via the outputs for capacity control (terminals 53 to 56) for purging, cooling or starting the burner. This control element moves to the required position for the relevant operating situation.

As soon as there is a purge signal at terminal 50 of BCU..F1/F2, the control element is activated by the outputs for capacity control to approach the position for pre-purge. The protective system (e.g. FCU 500) starts the pre-purge time if there is adequate air flow. After the elapse of the pre-purge time, the control element moves to the ignition position. Once the protective system (terminal 46, safety interlocks) has issued the enable signal, the pilot and main burners can be started by the start-up signals at terminals 1 and 4. The control element can be activated to control the burner's capacity dependent on parameters 48 and 49.

### **Modulating control**

Parameter 48 = 3

After the operating signal has been received from the burner and after expiry of the delay time for the controller enable signal (parameter 44), the BCU issues the controller enable signal via the output at terminal 56. Access to the control element is thus transferred to an external temperature controller (3-point step). The temperature controller controls the burner capacity (air volume) on the basis of the required temperature. Depending on the wiring of the temperature controller, the actuator may be adjusted between maximum capacity and ignition capacity or minimum capacity.

Depending on parameter 40, an actuator IC 20, IC 40, IC 50 or an actuator with an RBW interface can be actuated via the outputs for capacity control. Detailed information about parameter 40, see from page 75 (Capacity control).

### **Staged control**

P48 = 0, 1 or 2

Depending on parameters 48 and 49, the control element may be activated either by the program or externally via the input at terminal 2, see also from page 86 (Air actuator control).

## 4.1.2 BCU..F3

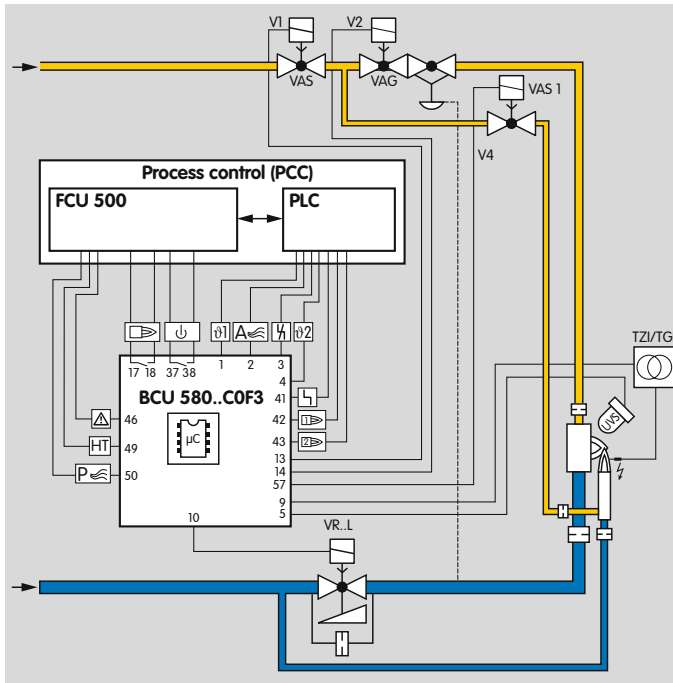

The BCU..F3 activates a PLC air valve for purging, cooling or starting the burner. The required air capacity is released by the air valve.

As soon as there is a purge signal at terminal 50 of BCU..F3, the air valve is activated by the output at terminal 10. The protective system (FCU 500) starts the pre-purge time if there is adequate air flow. After the elapse of the pre-purge time, the air valve closes for ignition. Once the protective system (terminal 46, safety

interlocks) has issued the enable signal, the burner can be started by the start-up signal at terminal 1. The gas valves for the 1<sup>st</sup> stage are opened and the burner is ignited (on the BCU..C1 after a successful valve check). After the operating signal has been received from the burner, the gas valve for the 2<sup>nd</sup> stage opens.

### Staged control

$P48 = 0, 1 \text{ or } 2$

Depending on parameters 48 and 49, the control element may be activated either by the program or externally via the input at terminal 2, see also from page 86 (Air actuator control).

## 5 Valve proving system

The BCU 500..C1 is fitted with an integrated valve proving system. This allows either the tightness of the gas solenoid valves and the pipework between them to be checked (tightness test) or the closed position of a solenoid valve (proof of closure function) to be checked.

Once the test has been carried out successfully, the burner enable signal is issued.

For details, see following chapter Tightness test and page 36 (Proof of closure function)

### 5.1 Tightness test

The aim of the tightness control is to identify an inadmissible leak on one of the gas solenoid valves and to prevent burner start. Gas solenoid valves V1 and V2 are tested as is the pipework between the valves.

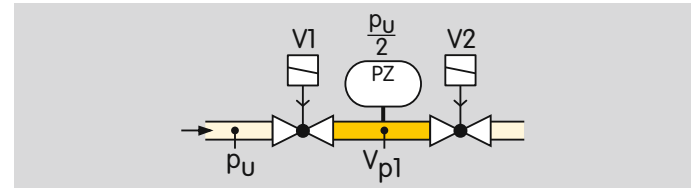

European standards EN 746-2 and EN 676 stipulate tightness controls for capacities over 1200 kW (NFPA 86: from 117 kW or 400,000 Btu/h).

The tightness control function satisfies the requirements of EN 1643, EN 746-2, ISO 13577-2 and NFPA 86 for valve proving systems.

### 5.1.1 Test instant

Depending on the parameter setting, the tightness control checks the tightness of the pipework and the gas solenoid valves before each start-up and/or after each shut-down of the burner, see page 95 (Valve proving system).

The gas line is always safeguarded by a gas solenoid valve during this check.

#### Before burner start-up

The valve check is started when the start-up signal  $\vartheta 1$  is present at terminal 1. The BCU checks the tightness of the gas solenoid valves and the pipework between the valves. The gas line is always safeguarded by a gas solenoid valve during this check. The pilot burner is ignited when pre-purge is ended and the tightness has been checked successfully.

#### After burner shut-down

After the burner has been shut down, the BCU checks the tightness of the gas solenoid valves and the pipe-work between them. Once the test has been carried out successfully, the next burner start is enabled.

The BCU always conducts a tightness test if mains voltage is available or if it is reset after a fault lock-out.

An additional bypass/relief valve must be installed in gas sections with an air/gas ratio control. This ensures that the test volume  $V_{p1}$  can be vented during the tightness test with the air/gas ratio control closed.

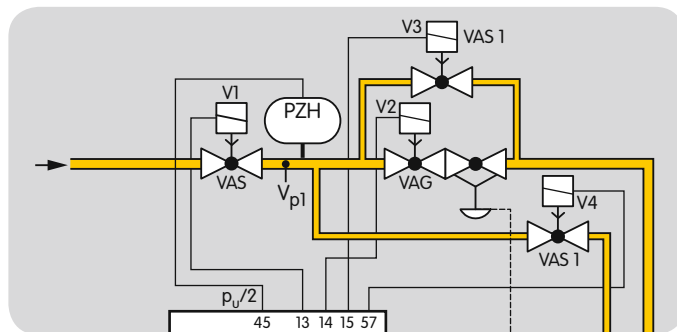
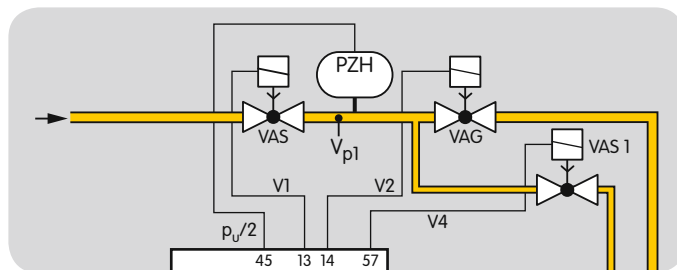

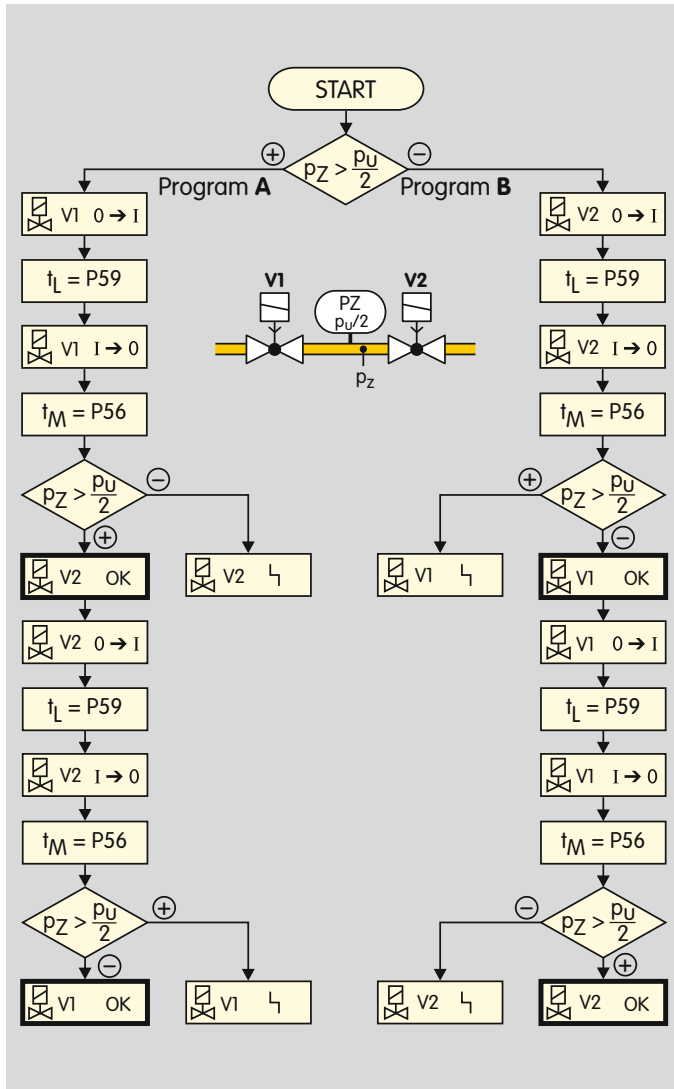

### 5.1.2 Program sequence

The tightness test starts by checking the external pressure switch. If pressure  $p_z > p_u/2$ , program A starts.

If pressure  $p_z < p_u/2$ , program B starts, see page 32 (Program B).

#### Program A

Valve V1 opens for the opening time  $t_L$  set in parameter 59. V1 closes again. During the measurement time  $t_M$ , the tightness control checks the pressure  $p_z$  between the valves.

If pressure  $p_z$  is less than half the inlet pressure  $p_u/2$ , valve V2 is leaking.

If pressure  $p_z$  is greater than half the inlet pressure  $p_u/2$ , valve V2 is tight. Valve V2 is opened for the set opening time  $t_L$ . V2 closes again.

During the measurement time  $t_M$ , the tightness control checks the pressure  $p_z$  between the valves.

If pressure  $p_z$  is greater than half the inlet pressure  $p_u/2$ , valve V1 is leaking.

If pressure  $p_z$  is less than half the inlet pressure  $p_u/2$ , valve V1 is tight.

The tightness test can only be performed if pressure  $p_d$  downstream of V2 is around atmospheric pressure and the volume downstream of V2 is at least  $5 \times$  higher than the volume between the valves.

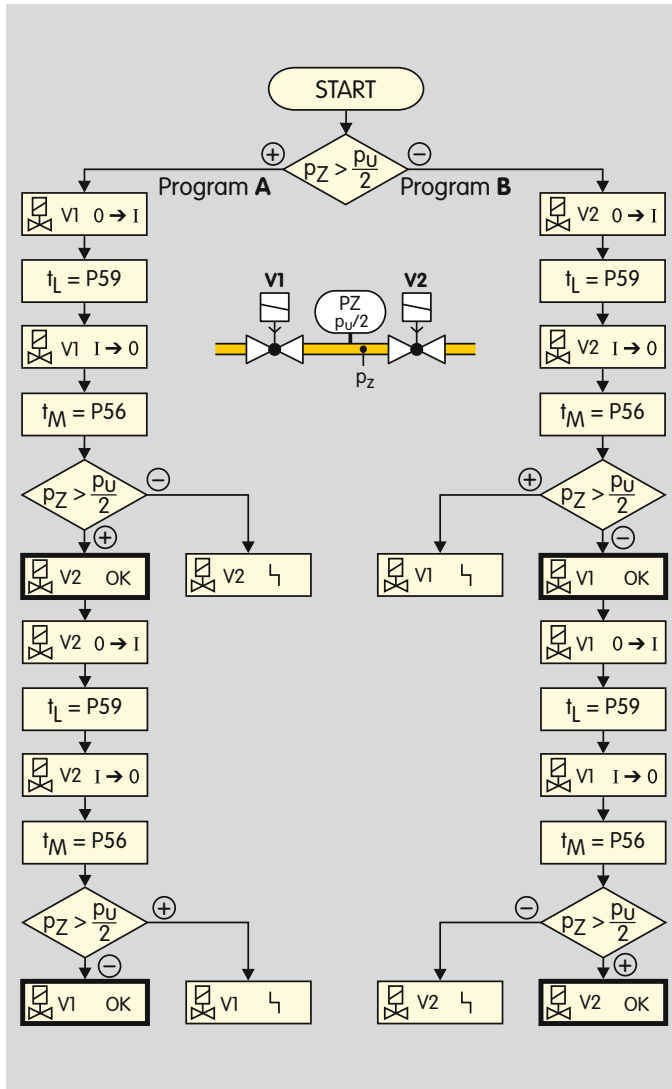

### Program B

Valve V2 opens for the set opening time  $t_L$ . V2 closes again. During the measurement time  $t_M$ , the tightness control checks the pressure  $p_Z$  between the valves.

If pressure  $p_Z > p_U/2$ , valve V1 is leaking.

If pressure  $p_Z < p_U/2$ , valve V1 is tight. Valve V1 is opened for the set opening time  $t_L$ . V1 closes again.

During the measurement time  $t_M$ , the tightness control checks the pressure  $p_Z$  between the valves.

If pressure  $p_Z < p_U/2$ , valve V2 is leaking.

If pressure  $p_Z > p_U/2$ , valve V2 is tight.

The tightness test can only be performed if pressure  $p_d$  downstream of V2 is around atmospheric pressure and the volume downstream of V2 is at least  $5 \times$  higher than the volume between the valves.



### 5.1.3 Test period $t_p$

Depending on the burner capacity, the tightness of the gas solenoid valves must be checked in accordance with the relevant application standard, e.g. EN 676, EN 746, NFPA 85 and NFPA 86.

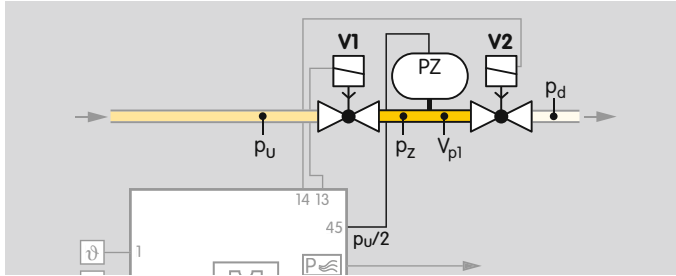

The test period  $t_p$  is calculated from:

- Opening times  $t_L$  for V1 and V2,
- Measurement times  $t_M$  for V1 and V2.

$$t_p [s] = 2 \times t_L + 2 \times t_M$$

### 5.1.4 Opening time $t_L$

Standard EN 1643:2000 allows a maximum opening time of 3 s for the tightness test if the main gas valves are actuated directly. If gas can flow into the combustion chamber when a valve is opened, the gas volume must not exceed 0.083 % of the maximum flow rate.

### 5.1.5 Measurement time $t_M$

The sensitivity of the tightness control in the BCU can be adjusted for each individual system by adapting the measurement time  $t_M$ . The longer the measurement

time  $t_M$ , the greater the sensitivity of the tightness control. The measurement time is set using parameter 56 to a value between 3 and 3600 s – see page 96 (Measurement time  $V_{p1}$ ).

The required measurement time  $t_M$  is calculated from:

Inlet pressure  $p_u$  [mbar]

Leakage rate  $Q_L$  [l/h]

Test volume  $V_{p1}$  [l]

Calculation of the test volume, see page 34 (Test volume  $V_{p1}$ )

### For one test volume $V_{p1}$ between 2 gas solenoid valves

Adjustable using parameter 56

$$t_M [s] = \left( \frac{2 \times p_u \times V_{p1}}{Q_L} \right)$$

### For a large test volume $V_{p1}$ with reduced testing time

Adjustable using parameter 56

$$t_M [s] = \left( \frac{0.9 \times p_u \times V_{p1}}{Q_L} \right)$$

Conversion into US units, see page 124 (Converting units)

## Valve proving system

### Leakage rate

The BCU tightness test ensures that the leakage rate  $Q_L$  is  $< 0.1\%$  of the maximum flow rate  $Q_{(N)\max.}$ .

$$\text{Leakage rate } Q_L \text{ [l/h]} = \frac{Q_{(N)\max.} \text{ [m}^3\text{/h]} \times 1000 \text{ [l/h]}}{1000 \times 1 \text{ [m}^3\text{/h]}}$$

### Test volume $V_{p1}$

Test volume  $V_{p1}$  is calculated from the valve volume  $V_V$ , added to the volume of the pipe  $V_R$  for each additional metre in length  $L$ .

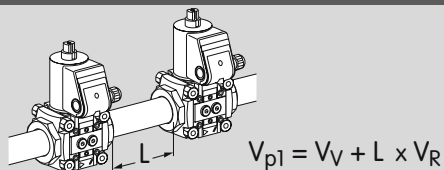

Valves		Pipework	
Type	Volume $V_V$ [l]	DN	Volume per metre $V_R$ [l/m]
VAS 1	0.25	10	0.1
VAS 2	0.82	15	0.2
VAS 3	1.8	20	0.3
VAS 6	1.1	25	0.5
VAS 7	1.4	40	1.3
VAS 8	2.3	50	2
VAS 9	4.3	65	3.3
VG 10	0.01	80	5
VG 15	0.07	100	7.9
VG 20	0.12	125	12.3
VG 25	0.2	150	17.7
VG 40/VK 40	0.7	200	31.4

VG 50/VK 50	1.2		250	49
VG 65/VK 65	2			
VG 80/VK 80	4			
VK 100	8.3			
VK 125	13.6			
VK 150	20			
VK 200	42			
VK 250	66			

The measurement time required for the test volume  $V_{p1}$  must be set on the basis of the calculation using parameter 56.

For the calculation, see page 35 (Calculation examples).

### Calculation examples

2 valves VAS 665,

distance  $L = 9.5 \text{ m}$ ,

inlet pressure  $p_U = 50 \text{ mbar}$ ,

max. flow rate  $Q_{(N)\text{max.}} = 200 \text{ m}^3/\text{h}$ .

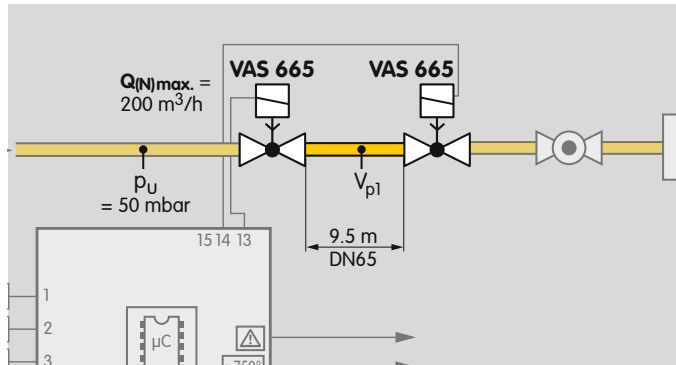

$$\text{Leakage rate } QL = \frac{200 \text{ m}^3/\text{h} \times 1000 \text{ l/h}}{1000 \times 1 \text{ m}^3/\text{h}} = 200 \text{ l/h}$$

Test volume  $V_{p1} = 1.1 \text{ l} + 9.5 \text{ m} \times 3.3 \text{ l/m} = 32.45 \text{ l}$   
see page 34 (Test volume  $V_{p1}$ )

### Measurement time for one test volume $V_{p1}$

Parameter 70 = 0

$$t_M [\text{s}] = \frac{2 \times 50 \text{ mbar} \times 32.45 \text{ l}}{200 \text{ l/h}} = 16.23 \text{ s}$$

Set the next highest value (20 s) using parameter 56,  
see page 96 (Measurement time  $V_{p1}$ ).

### 5.2 Proof of closure function

The proof of closure function monitors the function of the gas solenoid valve V1. The proof of closure function can be activated using parameter 51 = 4, see page 95 (Valve proving system).

A limit switch on gas solenoid valve V1 signals the closed position of the valve to the BCU (terminal 45) for this purpose.

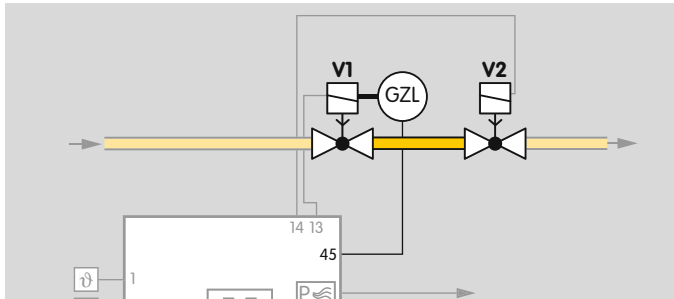

By checking the closed position using the proof of closure function, the BCU complies with the requirements of NFPA 85 (Boiler and Combustion Systems Hazards Code) and NFPA 86 (Standard for Ovens and Furnaces).

#### 5.2.1 Program sequence

When the start-up signal  $\vartheta 1$  is received at terminal 1, the BCU checks that valve V1 is in its closed position using the POC switch. After a timeout time of 10 s, a signal from the POC switch (valve V1 is closed) must be received at terminal 45. Otherwise, the BCU performs a fault lock-out with fault message c1.

As soon as the BCU has opened valve V1, it queries the open position of the valve via the POC switch. If a signal is still received at terminal 45 from the POC switch after a timeout time of 10 s, the BCU performs a fault lock-out with fault message c8.

## 6 BCSoft

The BCSoft engineering tool provides extended access to the BCU. BCSoft makes it possible to set device parameters on Windows-based PCs in order to adjust the BCU to the specific application. In addition, BCSoft provides extended access to the individual statistics and protocol functions.

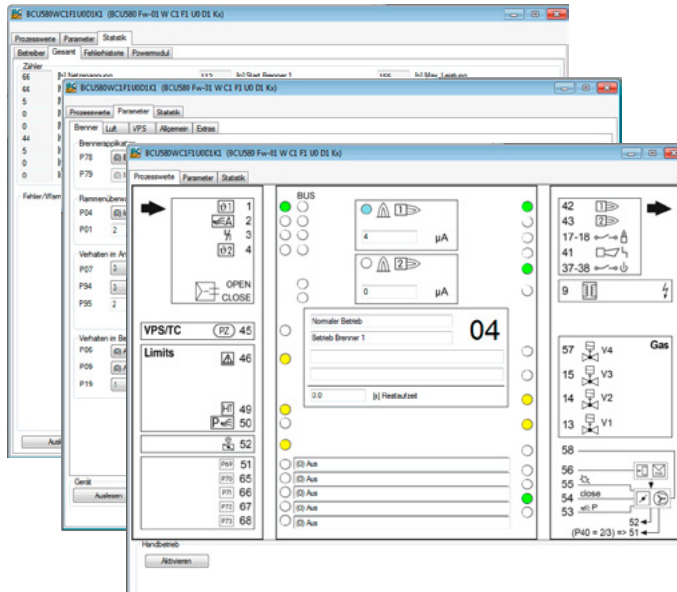

In addition to the engineering tool BCSoft, an opto-adapter or Bluetooth adapter is required to read the device parameters in and out, see also page 112 (BCSoft).

## 7 Profinet

Profinet is a manufacturer-independent, open standard for industrial Ethernet. It covers the requirements for automation technology (manufacturing automation, process automation, drive applications with or without functional safety).

Profinet is a bus variant for fieldbus communication, optimized for speed and low connection costs.

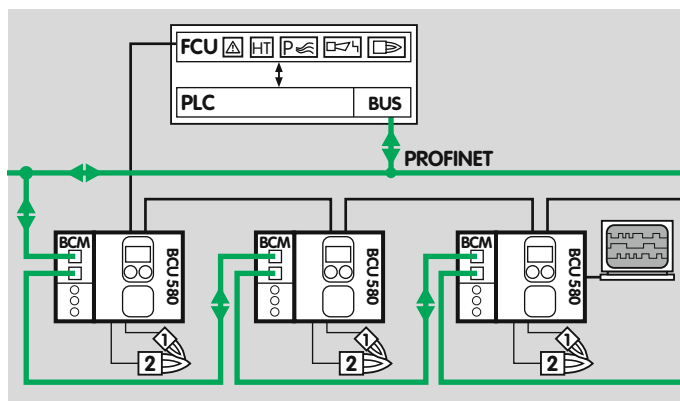

The basic function of Profinet is the exchange of process and required data between an IO controller (e.g. PLC) and several distributed IO devices (e.g. BCU/FCU).

The signals from the IO devices are read into the IO controller cyclically. There, they are processed and are then output to the IO devices again.

In addition to cyclic data exchange, Profinet also provides acyclic data exchange for events which are not

constantly repeated such as sending parameter settings and configuration data when the IO devices start up or sending a diagnostic message from the IO device to the IO controller during operation. The data read or written acyclically by read/write services are specified by an index, see page 48 (Indexes for acyclic communication).

The technical properties of an IO device are described by the manufacturer in a device master data file (GSD file). The GSD file contains the device image, the communications properties and all fault messages from the IO device in text form which are important for the configuration of the Profinet network and the data exchange. The configuration is completed using an engineering tool which is supplied by the manufacturer of the IO controller. Modules defined in the GSD file may be selected for configuration to include them in the system, see also page 41 (GSD file for PLC configuration).

## 7.1 BCU and bus module BCM

The optional bus module BCM 500 is required to integrate the BCU in the Profinet system.

Control signals (for start, reset and air actuator control), signal states from the device inputs and outputs and information about the device status (operating states, flame signal and current program step), warnings and faults can be transferred via the bus module between the BCU (IO device) and PLC (IO controller).

Bus module BCM 500 has two RJ45 connection sockets for connection to the fieldbus on its front. The connection sockets are combined with an internal 2-port switch. This allows the BCM 500 together with the BCU to be integrated in various network topologies (star, tree or line topology). Requirements such as Auto Negotiation and Auto Crossover are satisfied.



Safety-related signals and interlocks (e.g. safety interlock) must be wired independently of the fieldbus communication direct to the BCU and the protective system (e.g. FCU).

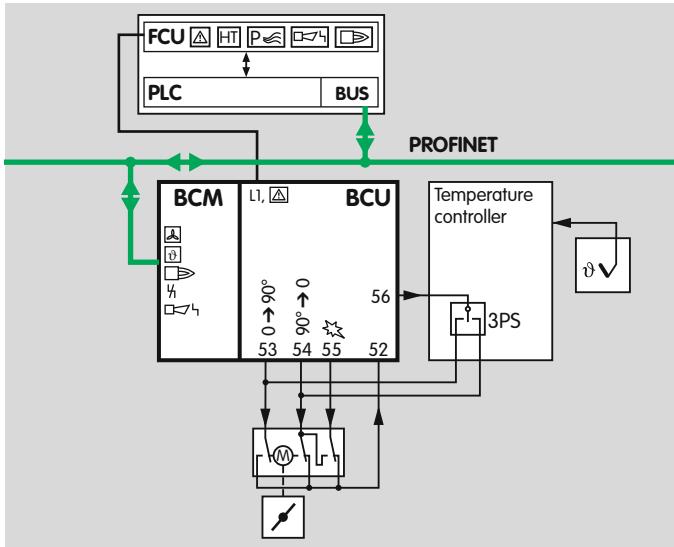

All network components which connect the automation system and the field devices must be certified for Profinet use.

For information on planning and the structure of a Profibus network and the components to be used (e.g. cables, lines and switches), see Profinet Installation Guide at [www.profibus.com](http://www.profibus.com).



## **7.2 GSD file for PLC configuration**

Before commissioning, the Profinet system must be configured for data exchange using an engineering tool.

The device master data file (GSD) is required for the integration of the BCU in the configuration of the PLC. The GSD file contains the device image and communications properties of the BCU. Modules defined in the GSD file may be selected for configuration to integrate the BCU, see page 42 (Modules for cyclic data exchange).

The GSD file for the bus module can be ordered at [www.docuthek.com](http://www.docuthek.com). The steps required to integrate the file are described in the instructions for the engineering tool for your automation system.

For parameter settings on the BCU and code switch settings on the BCM, see page 102 (Fieldbus communication).

### 7.2.1 Modules for cyclic data exchange

The modules for cyclic data exchange are defined in the GSD file for the bus module BCM 500. All modules required for cyclic data exchange between the controller and the burner control units BCU 580 are shown in the following table. The modules are assigned to the slots.

Module	Slot	Input address	Output address
Inputs/outputs	1	n...n+2	n
Burner 1 flame signal	2	n	
Burner 2 flame signal	3	n	
Status signal	4	n	
Fault and warning signals	5	n...n+1	
Remaining times	6	n...n+1	
TC remaining times <sup>1)</sup>	7	n...n+1	
PLC output information	8	n	
BCU input terminal information	9	n...n+2	
BCU output terminal information	10	n...n+1	
<sup>1)</sup> Only for BCU..C1. Slot 7 is not transferred with other device versions.			

## “Inputs/outputs” module – slot 1

The digital input and output signals from the burner control units BCU 560, BCU 565 and BCU 580 are included in this module.

### Input bytes (device → controller)

The input bytes describe the digital signals which are transferred from the BCU (IO device) to the digital inputs of the PLC (IO controller). The digital signals take up 2 bytes (16 bits).

Bit	Byte n	Byte n+1	Byte n+2	Format
0	Burner 1 operating signal	Max. capacity reached <sup>1)</sup>	menox ON	BOOL
1	Burner 2 operating signal	Min. capacity reached <sup>1)</sup>	Free	BOOL
2	BCU system fault	Air ON	Free	BOOL
3	Fault lock-out	Pre-purge ON	Free	BOOL
4	Safety shut-down	DI ON	Free	BOOL
5	Warning	Ready for operation	Free	BOOL
6	ON	Burner 2 flame signal	Free	BOOL
7	Manual mode	Burner 1 flame signal	Free	BOOL

<sup>1)</sup> Only with three-point step control via bus.

### Output byte (controller → device)

The output byte describes the digital signals which are output by the PLC (IO controller) to the BCU (IO device). The digital signals to control the burner control unit BCU occupy 1 byte (8 bits).

Parallel to the bus communication, terminals 1 to 4, 44 and 50 of the BCU can be wired. This allows the BCU to be controlled using the digital signals of the bus communication or the inputs at the terminals.

In the event that the bus communication is faulty or interrupted and during the initialization of the bus communication after switching on, the digital signals are interpreted as “0”. If the BCU is controlled using the inputs at the terminals during this time, the normal program runs even if the bus communication is faulty or interrupted.

Bit	Byte n	Format
0	Reset <sup>1)</sup>	BOOL
1	Burner 1 start <sup>1)</sup>	BOOL
2	External air ON <sup>1)</sup>	BOOL
3	Pre-purge ON	BOOL
4	Burner 2 start <sup>1)</sup>	BOOL
5	menox ON	BOOL
6	Open control element, three-point step Open <sup>2)</sup>	BOOL
7	Close control element, three-point step Close <sup>2)</sup>	BOOL

<sup>1)</sup> Parallel to the bus communication, terminals 1 to 4 can be wired.  
<sup>2)</sup> Only with three-point step control via bus.

**“Burner 1 flame signal” module (device → controller) – slot 2**

The flame signal for burner 1 is transferred from the BCU to the PLC as an analogue value using this module. The flame signal occupies one byte with values from 0 to 255 (= flame signal from 0 to 25.5 µA).

Bit	Byte n	Data type	Format	Value
0	Burner 1 flame signal	Byte	DEC	0 – 255 (0 – 25.5 µA)
1				
2				
3				
4				
5				
6				
7				

**“Burner 2 flame signal” module (device → controller) – slot 3**

The flame signal for burner 2 is transferred from the BCU to the PLC as an analogue value using this module. The flame signal occupies one byte with values from 0 to 255 (= flame signal from 0 to 25.5 µA).

Bit	Byte n	Data type	Format	Value
0	Burner 2 flame signal	Byte	DEC	0 – 255 (0 – 25.5 µA)
1				
2				
3				
4				
5				
6				
7				

**“Status signal” module (device → controller) – slot 4**

This module transfers the status signals from the BCU to the PLC. The status signals occupy one byte (0 to 255). Every status signal is allocated a code. The allocation is described in the code table “GSD Codes BCU 580”.

Bit	Byte n	Data type	Format	Value
0	Status signals	Byte	DEC	0 – 255 (see Code table “GSD_ Codes_BCU580.xlsx” at www.docuthek.com)
1				
2				
3				
4				
5				
6				
7				

**“Fault and warning signals” module (device → controller) – slot 5**

The fault and warning signals are transferred from the BCU to the PLC using this module. The fault and warning signals occupy one byte each (0 to 255).

The allocation of the output codes to the fault and warning signals is described in the code table “GSD Codes BCU 580”. The same allocation table applies to the fault signals and the warning signals.

Bit	Byte n	Data type	Format	Value
0	Fault signals	Byte	DEC	0 – 255 (see Code table “GSD_Codes_ BCU580.xlsx” at <a href="http://www.docuthek.com">www.docuthek.com</a> )
1				
2				
3				
4				
5				
6				
7				

Bit	Byte n+1	Data type	Format	Value
0	Warning signals	Byte	DEC	0 – 255 (see Code table “GSD_Codes_ BCU580.xlsx” at <a href="http://www.docuthek.com">www.docuthek.com</a> )
1				
2				
3				
4				
5				
6				
7				

**“Remaining times” module (device → controller) – slot 6**

This module transfers the remaining times of various processes from the BCU to the PLC. The remaining time occupies 2 bytes.

Bit	Byte n	Byte n+1	Data type	Format	Value
0	Remaining times		Word	DEC	0 – 6554 (0 – 6554 s)
1					
2					
3					
4					
5					
6					
7					

**“Remaining times of the valve proving system” module (device → controller) – slot 7**

Only for BCU..C1.

The module in BCU..C0 contains no information.

This module transfers the remaining time of the valve proving system from the BCU..C1 to the PLC. The remaining time occupies 2 bytes.

The valve check runs parallel to other time-related processes, e.g. pre-purge. To display the remaining time of the valve proving system separately, it is transferred separately.

Bit	Byte n	Byte n+1	Data type	Format	Value
0	Remaining times of the valve proving system		Word	DEC	0 – 6554 (0 – 6554 s)
1					
2					
3					
4					
5					
6					
7					

**“PLC output information” module (device → controller) – slot 8**

This module transfers information on signals which the PLC uses to control the BCU back to the PLC. This allows the signal transfer from the PLC to the BCU to be checked.

Bit	Byte n	Format
0	Reset	BOOL
1	Burner 1 start	BOOL
2	External air ON	BOOL
3	Pre-purge ON	BOOL
4	Free	BOOL
5	menox ON	BOOL
6	Open control element, three-point step Open <sup>1)</sup>	BOOL
7	Close control element, three-point step Close <sup>1)</sup>	BOOL

<sup>1)</sup> Only with three-point step control via bus.

**“BCU input terminal information” module (device → controller) – slot 9**

This module transfers the signal states of the digital inputs on the BCU (input terminals) to the PLC.

Bit	Byte n	Byte n+1	Byte n+2	Format
0	Terminal 1	Terminal 48	Terminal 68	BOOL
1	Terminal 2	Terminal 49	Free	BOOL
2	Terminal 3	Terminal 50	Free	BOOL
3	Free	Terminal 51	Free	BOOL
4	Terminal 44	Terminal 52	Free	BOOL
5	Terminal 45	Terminal 65	Free	BOOL
6	Terminal 46	Terminal 66	Free	BOOL
7	Terminal 47	Terminal 67	Free	BOOL

**“BCU output terminal information” module (device → controller) – slot 10**

This module transfers the signal states of the digital outputs on the BCU (output terminals) to the PLC.

Bit	Byte n	Byte n+1	Format
0	Terminal 9	Terminal 42	BOOL
1	Terminal 10	Terminal 43	BOOL
2	Terminal 13	Terminal 53 <sup>1)</sup>	BOOL
3	Terminal 14	Terminal 54	BOOL
4	Terminal 15	Terminal 55	BOOL
5	Terminal 17/18	Terminal 56	BOOL
6	Terminal 37/38	Terminal 57	BOOL
7	Terminal 41	Free	BOOL

<sup>1)</sup> Only for BCU..F2: terminal 53 is used as an input.  
Bit 6 has no function.

## 7.2.2 Indexes for acyclic communication

With the help of acyclic communication between the PLC (IO controller) and BCU/FCU (IO devices), it is possible to read information on parameters, statistics and fault history on an event basis (e.g. using system function block Siemens FSB 52 RDREC).

The available data records differ in terms of their indexes.

Index	Description
1001	Parameter
1002	Device statistics, counter
1003	Device statistics, faults/warnings
1004	Operator statistics, counter
1005	Operator statistics, faults/warnings
1006	Fault history
1007	Power module statistics

The contents and description of the indexes are described in the code table “GSD Codes BCU 580” (download from [www.docuthek.com](http://www.docuthek.com)).









## 8 Program step/status

DISPLAY <sup>1)</sup>	Program step/status
00	Initializing
R0	Cooling <sup>2)</sup>
P0	Pre-purge
H0	Delay
01	Burner pause time $t_{BP}$
R1	Pre-ventilation <sup>2)</sup>
H1	Delay
Rc	Approaching minimum capacity <sup>2)</sup>
Ro	Approaching maximum capacity <sup>2)</sup>
Ri	Approaching ignition capacity <sup>2)</sup>
tc	Valve check
02	Safety time 1
R2	Safety time 1
H2	Delay
03	Flame proving period 1 $t_{FS1}$
R3	Flame proving period 1 $t_{FS1}$
04	Burner 1 operation
R4	Burner 1 operation
H4	Delay
H5	Delay
06	Safety time 2
R6	Safety time 2
07	Flame proving period 2

## Program step/status

---

DISPLAY <sup>1)</sup>	Program step/status
	Flame proving period 2
	Burner 2 operation
	Burner 2 operation
	Delay
	Remote control with OCU
	Data transfer (programming mode)
	Device Off

1) In Manual mode, two dots blink on the display.

2) Air actuator (control element/valve) is open.

## 9 Fault signalling

Fault message (blinking)	DISPLAY	Description
Burner 1 flame simulation	01	Flame simulation/flame signal before ignition
No flame after safety time 1	02	No flame formation to end of 1 <sup>st</sup> safety time
Flame failure during flame proving period 1 $t_{FS1}$	03	
Flame failure during burner 1 operation	04	Flame failure during operation
Burner 2 flame simulation	05	Flame simulation/flame signal before burner 2 start
Flame failure during safety time 2	06	No flame formation to end of 2 <sup>nd</sup> safety time
Flame failure during flame proving period 2	07	
Flame failure during burner 2 operation	08	Flame failure during operation
Too many remote resets	10	Remote reset activated > 5 × in 15 min.
Too many restarts	11	> 5 restarts in 15 minutes
Too many restarts for burner 2	12	> 5 restarts in 15 minutes
Controller enable output (terminal 56)	20	Controller enable output incorrectly connected/supplied with power from an external source
Simultaneous activation (terminals 51 and 52)	21	"Maximum capacity" and "Ignition capacity" position feedback from butterfly valve set simultaneously
Actuator wiring (terminals 52 – 55)	22	Faulty wiring of terminals 52 to 55
Actuator feedback (terminal 52)	23	Maximum or ignition capacity is not constantly signalled back to terminal 52
Simultaneous Min./Max. bus command	24	"Open actuator" and "Close actuator" bus signals set simultaneously
Non-fail-safe parameters (NFS) inconsistent	30	NFS parameter range is inconsistent
Fail-safe parameters (FS) inconsistent	31	FS parameter range is inconsistent
Mains voltage	32	Operating voltage too high/low
Faulty parameterization	33	Parameter set contains illegal settings
Incompatible bus module	35	
Power module defective	36	Relay contact error
Fuse defective	39	Device fuse F1 is defective

## Fault signalling

Fault message (blinking)	DISPLAY	Description
Inlet valve(s) leaking	40	Leak found on inlet valve
Outlet valve(s) leaking	41	Leak found on outlet valve
Pressure switch/gas valve wiring	44	
Gas valve wiring	45	Reversed valve connection
Safety interlock failure	51	
Permanent remote reset	52	Remote reset input activated > 25 s
Timing cycle too short	53	Minimum timing cycle not observed
Waiting for ignition position (LDS)	54	Faulty feedback signal of the control element position for ignition capacity
Wiring for multi-flame control	56	Faulty wiring for multi-flame control
Internal error	80	Flame amplifier error/device error
Internal error	89	Error in processing internal data
Internal error	94	Error at digital inputs
Internal error	95	Error at digital outputs
Internal error	96	Error when checking the SFR
Internal error	97	Error when reading the EEPROM
Internal error	98	Error when writing to the EEPROM
emBoss	99	Shut-down without application error
Minimum capacity not reached	Ac	Position for minimum capacity has not been reached after 255 s
Maximum capacity not reached	Ad	Position for maximum capacity has not been reached after 255 s
Ignition capacity not reached	Ai	Position for ignition capacity has not been reached after 255 s
Communication with bus module	bE	Bus module fault
Parameter chip card (PCC)	bc	Incorrect or defective PCC
POC valve open	c1	Valve not closed
POC valve closed	cB	Valve not open

## Fault signalling

Fault message (blinking)	DISPLAY	Description
Air monitor "no flow" state		Fault Air monitor "no flow" state check
Low air pressure		Fault Air monitor operating check
Low air pressure		Low air pressure during program step 2, 3, 4, 5, 6, 7 or 8
Air flow during pre-purge		Air flow failure during pre-purge
Waiting for connection		BCU waiting for connection to controller
Invalid address		Invalid or incorrect address set on bus module
Invalid configuration		The bus module has received an incorrect configuration from the controller
Invalid network name		Invalid network name or no address allocated in the network name
Controller in STOP position		Controller in STOP position
Burner 1 flame simulation		Burner 1 flame simulation while air valve open
No flame after safety time 1		No flame during safety time 1 while air valve open
Flame failure during flame proving period 1		Flame failure during flame proving period 1 while air valve open
Flame failure during burner 1 operation		Flame failure during burner 1 operation while air valve open
Burner 2 flame simulation		Burner 2 flame simulation while air valve open
Flame failure during safety time 2		No flame during safety time 2 while air valve open
Flame failure during flame proving period 2		Flame failure during flame proving period 2 while air valve open
Flame failure during burner 2 operation		Flame failure during burner 2 operation while air valve open

## 10 Parameters

Any changes to parameters will be saved to the parameter chip card.

Name	Parameter	Value range	Description	Factory default settings
Burner 1 FS1 flame signal switch-off threshold	01	0 – 20	Burner 1 FS1 flame signal switch-off threshold in $\mu\text{A}$	2 (5 when P04 = 1)
Burner 2 flame signal switch-off threshold FS2	02	0 – 20	Burner 2 FS2 flame signal switch-off threshold in $\mu\text{A}$	2 (5 when P04 = 1)
Flame control	04	0 1 2 3 4 5 6 7 8	Ionization UVS UVD Ionization1 and UVS 2 Ionization1 and UVD 2 UVS 1 and ionization 2 UVD 1 and UVD 2 UVD 1 and ionization 2 UVD 1 and UVS 2	0
High temperature operation	06	0 2 3	Off Intermittent operation with UVS Continuous operation with ionization/UVD	0
Burner 1 start-up attempts	07	1 2 3	1 start-up attempt 2 start-up attempts 3 start-up attempts	1
Burner 2 start-up attempts	08	1 2 3	1 start-up attempt 2 start-up attempts 3 start-up attempts	1
Restart	09	0 1 2 3 4 5 6	Off Burner 1 Burner 2 Burner 1 and burner 2 Max. 5 × in 15 min. for burner 1 Max. 5 × in 15 min. for burner 2 Max. 5 × in 15 min. for burner 1 and burner 2	0
Safety time during operation	19	0; 1; 2	Time in seconds	1

## Parameters

Name	Parameter	Value range	Description	Factory default settings
Capacity control	40	0 1 2 3 5	Off With IC 20 With IC 40 With RBW With air valve	BCU..F0 = 0 BCU..F1 = 1 BCU..F2 = 3 BCU..F3 = 5
Running time selection	41	0 1 2 3	Off; checking the positions for minimum/maximum capacity On; for approaching the positions for minimum/maximum capacity On; for approaching the position for maximum capacity On; for approaching the position for minimum capacity	0
Running time	42	0 – 250	Running time in seconds if parameter 41 = 1, 2 or 3	30
Low fire over-run	43	0 1 2 3 4 5 6 7 8 9 10	Off Up to minimum capacity 1 s 2 s 3 s 4 s 5 s 10 s 20 s 30 s 40 s	1
Controller enable signal delay time tRF	44	0 – 250	Time in seconds	0
Air actuator control	48	0 1 2 3 4	Opens on external activation Opens with gas stage 1 Opens with operating signal Controller enable following operating signal or in standby Opens with V4 pilot burner	0

## Parameters

Name	Parameter	Value range	Description	Factory default settings
Air actuator can be activated externally on start-up	49	0 1	Cannot be activated Can be activated externally	0
Air actuator in the event of fault	50	0 1	Cannot be activated Can be activated externally	1
Valve proving system	51	0 1 2 3 4	Off Tightness test before start-up Tightness test after shut-down Tightness test before start-up and after shut-down Proof of closure function	0
Relief valve (VPS)	52	2 3 4	V2 V3 V4	2
Measurement time Vp1	56	3 5 – 25 30 – 3600	Time in seconds in 5 s steps in 10 s steps	10
Valve opening time 1 tL1	59	2 – 25	Time in seconds	2
Minimum operating time tB	61	0 – 250	Time in seconds	0
Minimum pause time tBP	62	0 – 3600	Time in seconds	0
Operating time in Manual mode	67	0 1	Unlimited 5 minutes	1
Function of terminal 50	68	23 24	Purge with Low signal Purge with High signal	24
Function of terminal 51	69	0 8 13	Off AND with emergency stop (trm. 46) Max. capacity position feedback (IC 40/RBW)	0
Function of terminal 65	70	0 8	Off AND with emergency stop (trm. 46)	0
Function of terminal 66	71	0 8 20	Off AND with emergency stop (trm. 46) LDS ignition position check	0
Function of terminal 67	72	0 8 21	Off AND with emergency stop (trm. 46) Multi-flame control (MFC) start-up conditions	0
Function of terminal 68	73	0 8 22	Off AND with emergency stop (trm. 46) Multi-flame control (MFC) operating conditions	0



## Parameters

Name	Parameter	Value range	Description	Factory default settings
Capacity control (bus)	75	0	Off	0
		1	MIN. to MAX. capacity; standby in position for MIN. capacity	
		2	MIN. to MAX. capacity; standby in CLOSED position	
		3	IGNITION to MAX. capacity; standby in CLOSED position	
		4	MIN. to MAX. capacity; standby in position for MIN. capacity; burner quick start	
		5	IGNITION to MAX. capacity; standby in CLOSED position; burner quick start	
Password	77	0000 – 9999	Four-digit number code	1234
Burner application	78	0	Burner 1	2
		1	Burner 1 with pilot gas	
		2	Burner 1 and burner 2	
		3	Burner 1 and burner 2 with pilot gas	
		4	Two-stage burner 1	
		5	Burner 1 and two-stage burner 2	
Pilot burner	79	0	With shut-down	0
		1	In continuous operation	
Fieldbus communication	80	0	Off	1
		1	With address check	
		2	No address check	
Safety time 1 tSA1	94	2, 3, 5, 10	Time in seconds	5
Flame proving period 1 tFS1	95	0 – 20	Time in seconds	2
Safety time 2 tSA2	96	2, 3, 5, 10	Time in seconds	5
Flame proving period 2 tFS2	97	0 – 20	Time in seconds	2

### 10.1 Scanning the parameters

During operation, the 7-segment display shows the program step/status.

All the parameters of the BCU can be scanned in numerical order by repeatedly pressing the Reset/Information button (for 1 s).

The parameter display is ended 60 seconds after the last time the button is pressed or by switching off the BCU.

The BCU indicates  when the mains switch has been switched off. The parameters cannot be scanned when the BCU is switched off or when a fault message is displayed.

### 10.2 Flame control

The BCU is fitted with a flame amplifier which evaluates whether an adequate flame signal is supplied by the burner using an ionization electrode or UV sensor.

#### 10.2.1 Switch-off threshold of the flame amplifier

##### **Burner 1 FS1 flame signal switch-off threshold**

Parameter 01

The sensitivity at which the burner control unit detects a flame at burner 1 can be set using parameter 01.

In the case of UV control, this value can be increased, should the burner to be monitored be influenced by other burners for example.

##### **Burner 2 flame signal switch-off threshold FS2**

Parameter 02

The sensitivity at which the burner control unit detects a flame at burner 2 can be set using parameter 02.

In the case of UV control, this value can be increased, should the burner to be monitored be influenced by other burners for example.

##### **During start-up**

If the measured flame signal falls below the set value (2 to 20  $\mu\text{A}$ ) during the start-up after elapse of safety time 1, the BCU performs a safety shut-down with subsequent fault lock-out or up to two further start-up attempts. The number of start-up attempts can be defined using parameter 07, see page 63 (Burner 1 start-up attempts).

##### **During operation**

If the measured flame signal falls below the set value (2 to 20  $\mu\text{A}$ ) during operation after elapse of the safety time during operation (parameter 19), the BCU performs a safety shut-down with subsequent fault lock-out or a restart. The restart function can be defined using parameter 09, see page 70 (Restart).

### 10.2.2 Flame control

#### Parameter 04

Parameter 04 = 0: flame control is performed with an ionization electrode.

Parameter 04 = 1: flame control is performed with a UV sensor for intermittent operation (UVS).

Parameter 04 = 2: flame control is performed with a UV sensor for continuous operation (UVD).

Parameter 04 = 3: burner 1 flame control is performed with an ionization electrode. Burner 2 flame control is performed with a UV sensor for intermittent operation (UVS).

Parameter 04 = 4: burner 1 flame control is performed with an ionization electrode. Burner 2 flame control is performed with a UV sensor for continuous operation (UVD).

Parameter 04 = 5: burner 1 flame control is performed with a UV sensor for intermittent operation (UVS). Burner 2 flame control is performed with an ionization electrode.

Parameter 04 = 6: burner 1 and burner 2 flame control is performed with a UV sensor for intermittent operation (UVS) on each burner.

Parameter 04 = 7: burner 1 flame control is performed with a UV sensor for continuous operation (UVD). Burner 2 flame control is performed with an ionization electrode.

Parameter 04 = 8: burner 1 flame control is performed with a UV sensor for continuous operation (UVD). Burner 2 flame control is performed with a UV sensor for intermittent operation (UVS).

#### UV sensor for intermittent operation

For intermittent operation, the operating state of the complete system is limited to 24 h pursuant to EN 298. To meet the requirement for intermittent operation, the burner is shut down and restarted automatically after an operating time of 24 hours. The restart does not meet the requirements of EN 298 for UV sensor continuous operation because the required self-test (at least once per hour) is not performed while the burner is operating.

This shut-down and subsequent restart are performed in the same way as a normal controlled shut-down. This process is controlled independently by the BCU and therefore it must be checked whether the industrial process permits the pause in heat supply it creates.

#### UV sensor for continuous operation

The reaction times of the BCU and UV sensor for continuous operation are coordinated so that the set safety time during operation (parameter 19) is not extended.

### 10.2.3 High temperature operation

Parameter O6

#### Operation of firing systems at temperatures above 750°C

The BCU..D1 and BCU..D2 have a fail-safe input with the function “High temperature operation”. If firing systems are operated above 750°C, the system is considered to be an item of high temperature equipment (see EN 746-2). Here, flame control must be in operation until the furnace wall temperature has exceeded 750°C.

Below 750°C, the flame is monitored by conventional means (UV sensor or ionization electrode). In High temperature mode (> 750°C), the flame may be controlled via the temperature using a safety temperature monitor (STM) in order to increase the system’s availability. This means that no incorrect flame signals, e.g. signals from a UV sensor which interprets reflected UV radiation as extraneous signals, may lead to faults.

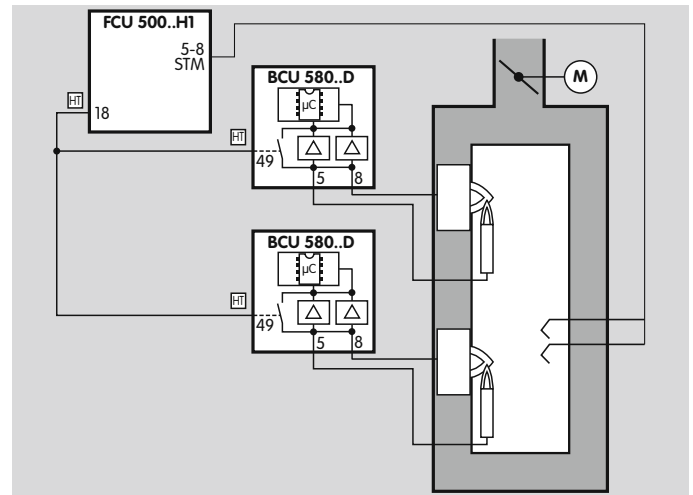

When the HT input is activated (terminal 49), the burner control unit reverts to High temperature mode, i.e.: **the BCU operates without evaluation of the flame signal. The safety function of the device-internal flame control system is deactivated.**

In High temperature mode, the gas valves are opened and the burners are started as usual without monitoring the presence of a flame.

## Parameters

The precondition for this operating mode is that an external flame supervision device ensures the presence of the flame in a fail-safe manner indirectly via the temperature. For this purpose, we recommend a safety temperature monitor with double thermocouple (DIN 3440). The flame must be monitored again by conventional means (UV sensor or ionization electrode) in the event of sensor discontinuity or short-circuit, failure of the safety temperature monitor or power failure.

Only if the temperature at the furnace wall has exceeded 750°C may voltage be applied to the HT input (terminal 49) so as to activate High temperature mode.

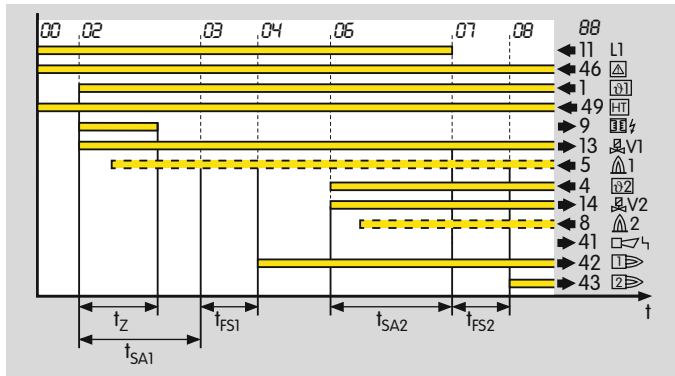

If the temperature in the furnace chamber drops below 750°C, the HT input must be disconnected from the electrical power supply and the furnace must then be operated with flame control.

The BCU then responds, depending on setting:

Parameter 06 = 0

The High temperature mode function is switched off. Flame control takes place dependent on the setting in parameter 04 (by ionization electrode, UVS sensor or UVD sensor).

Parameter 06 = 2 (BCU..D1)

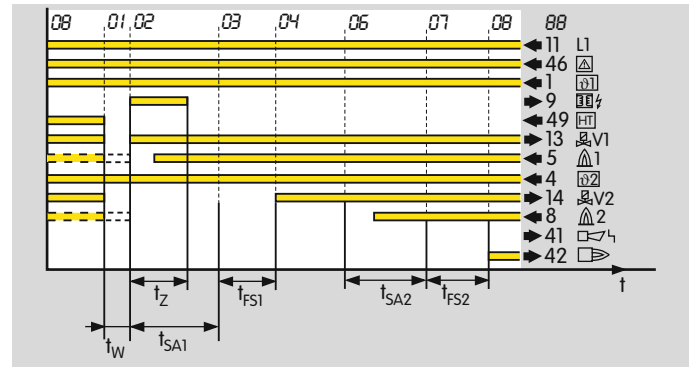

The BCU switches off the burner once the HT input has been disconnected from the electrical power supply and restarts with flame simulation check (recommended in the case of UV control with UVS).

## Parameters

Parameter O6 = 3 (BCU..D1)

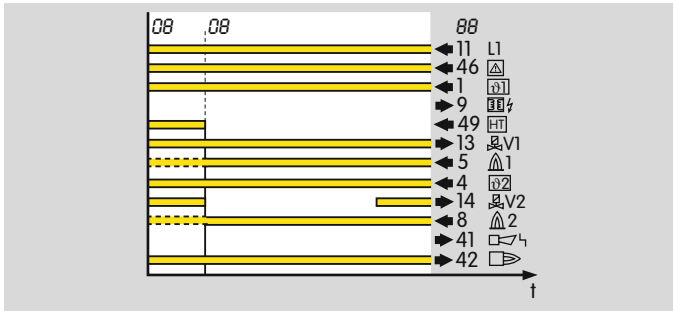

Despite the HT input having been disconnected from the electrical power supply, the burner remains in operation. The BCU performs flame control again (recommended in the case of ionization control or UV control with UVD).

If no flame signal is present when High temperature mode is deactivated, the burner control unit performs a fault lock-out, regardless of parameter O6.

Fault, pilot burner

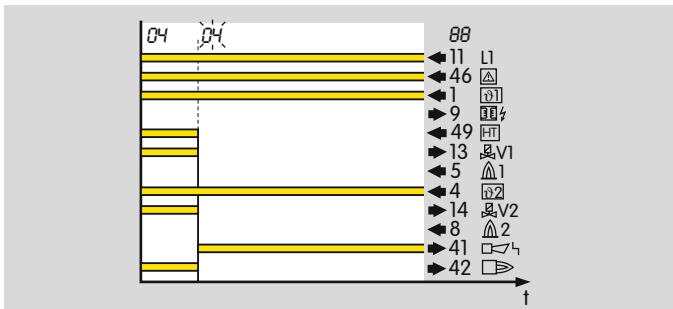

Fault, main burner

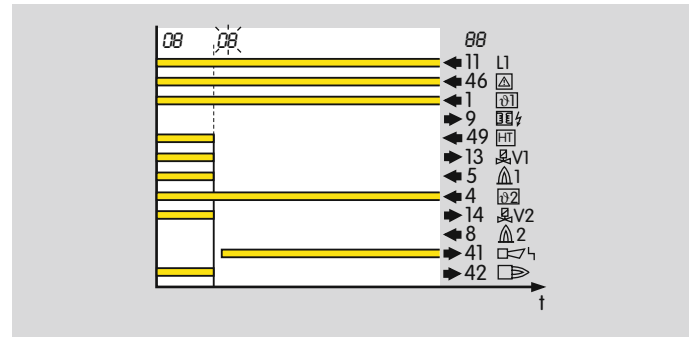

## 10.3 Behaviour during start-up

### 10.3.1 Burner 1 start-up attempts

Parameter 07

Up to three start-up attempts are possible in certain conditions. In accordance with EN 746-2, a restart may be conducted only if the safety of the installation is not impaired. Note the requirements of the standards!

For FM and CSA approved units, it is only possible to select one start-up attempt (P07 = 1).

This parameter defines the maximum number of possible start-up attempts of burner 1.

If no flame is detected during start-up, an immediate fault lock-out (P07 = 1) or up to two additional start-up attempts (P07 = 2, 3) are performed depending on parameter 07.

Parameter 07 = 1: 1 start-up attempt.

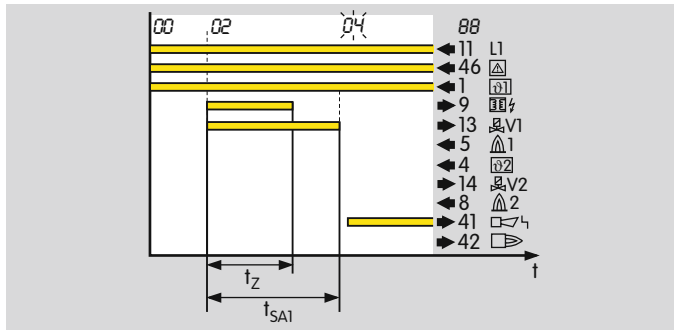

If no flame is formed during the start-up so that at the end of the safety time  $t_{SA1}$  no flame signal is detected, this will result in a BCU safety shut-down with subsequent fault lock-out. The fault message 04 will flash in the BCU display depending on the burner operating mode.

Parameter 07 = 2, 3: two or three start-up attempts.

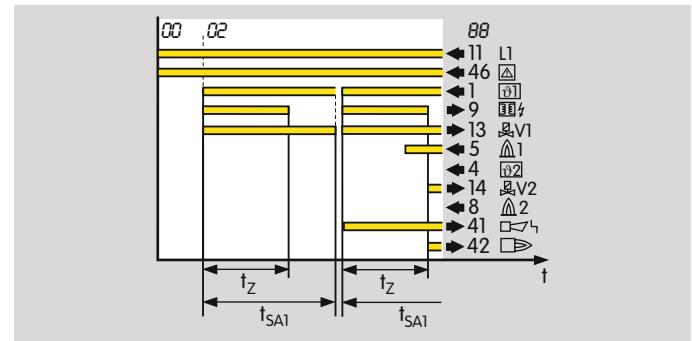

If no flame is formed during the start-up so that at the end of the safety time  $t_{SA1}$  no flame signal is detected, the BCU closes the gas valves and repeats the start-up. Each start-up attempt begins with the parameterized start-up behaviour.

If the safety time  $t_{SA1}$  elapses without a flame signal having been detected, even after the last parameterized start-up attempt, this will result in a BCU safety shut-down with subsequent fault lock-out. The fault message 04 will flash in the BCU display depending on the burner operating mode.

### 10.3.2 Burner 2 start-up attempts

Parameter 08

**Up to three start-up attempts are possible in certain conditions. In accordance with EN 746-2, a restart may be conducted only if the safety of the installation is not impaired. Note the requirements of the standards!**

**For FM and CSA approved units, it is only possible to select one start-up attempt (P08 = 1).**

This parameter defines the maximum number of possible start-up attempts of burner 2.

If no flame is detected during start-up, an immediate fault lock-out (P08 = 1) or up to two additional start-up attempts (P08 = 2, 3) are performed depending on parameter 08.

Parameter 08 = 1: 1 start-up attempt.

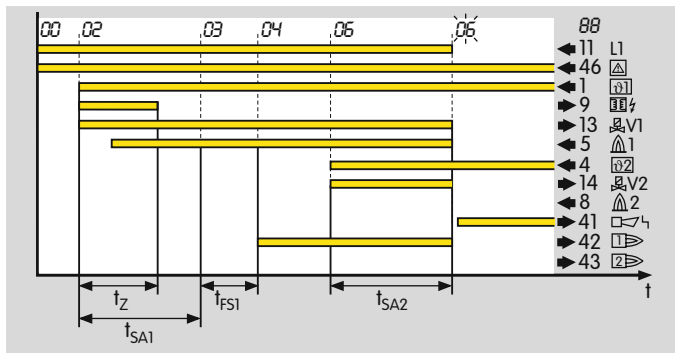

If no flame is formed during the start-up so that at the end of the safety time  $t_{SA1}$  no flame signal is detected,

this will result in a BCU safety shut-down with subsequent fault lock-out. The fault message 05 will flash in the BCU display depending on the burner operating mode.

Parameter 08 = 2, 3: two or three start-up attempts.

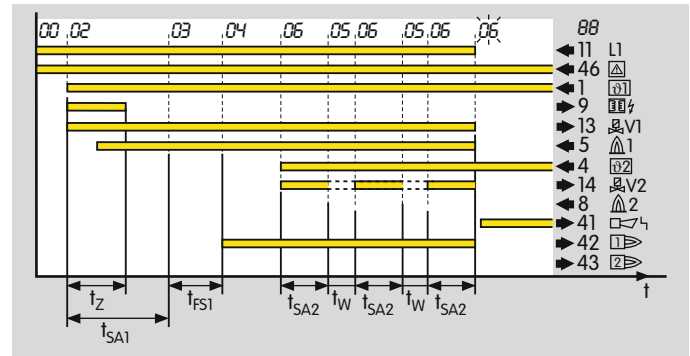

If no flame is formed during the start-up so that at the end of the safety time  $t_{SA2}$  no flame signal is detected, the BCU closes the gas valves and repeats the start-up. Each start-up attempt begins with the parameterized start-up behaviour.

If the safety time  $t_{SA2}$  elapses without a flame signal having been detected, even after the last parameterized start-up attempt, this will result in a BCU safety shut-down with subsequent fault lock-out. The fault message 05 will flash in the BCU display depending on the burner operating mode.



## 10.3.3 Burner application

### Parameter 78

This parameter enables the BCU to be adjusted to various burner applications. In addition, an optional pilot gas valve (V3) can be parameterized via which the burner is started with a defined ignition capacity.

Parameter 78 = 0: burner 1. Two valves (V1, V2) are included for the burner. These are connected to the valve outputs (terminals 13 and 14). Valves V1 and V2 are opened in parallel to start the burner in order to release the gas supply to the burner.

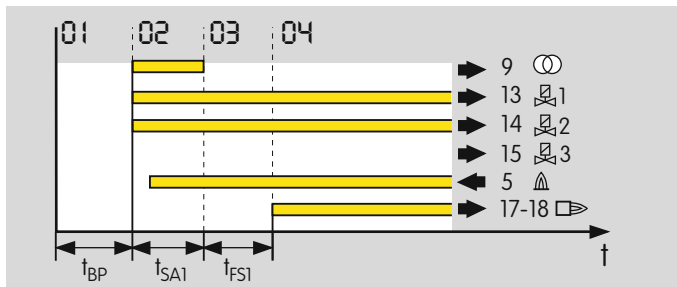
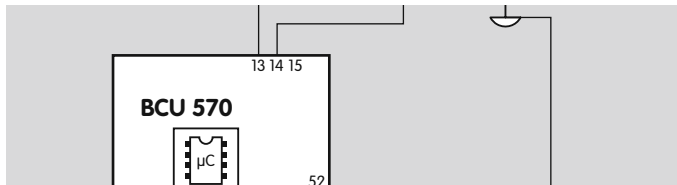

Parameter 78 = 1: burner 1 with pilot gas. Three valves (V1, V2 and V3) are included for a burner with a pilot gas valve. These are connected to the valve outputs (terminals 13, 14 and 15). Valves V1 and V3 open to

start the burner. The burner is started with a limited ignition capacity using gas valve V3. After the elapse of the safety time  $t_{SA1}$  (program step 02), valve V2 opens. Valve V3 limits the ignition capacity. After the elapse of the flame proving period  $t_{FS1}$  (program step 04), it is closed again.

For this application, it must be ensured that the flame proving period (P95) is set to a value  $\geq 2$  s.

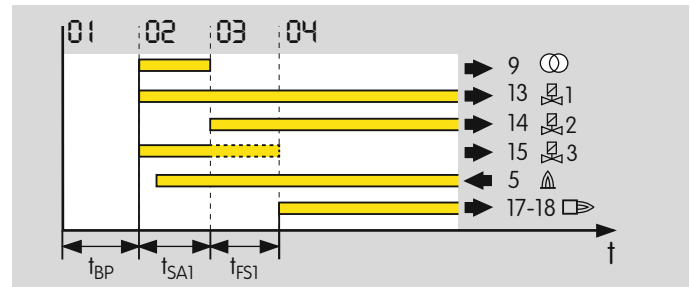
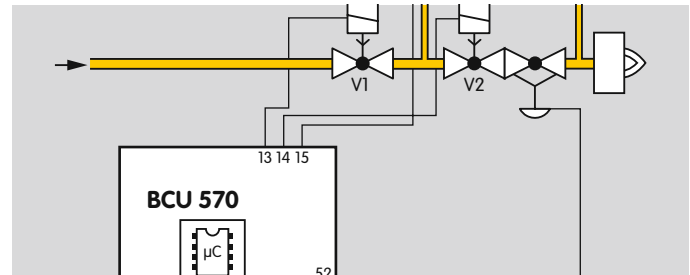

## Parameters

Parameter 78 = 2: burner 1 and burner 2. Three valves (V1, V2 and V4) are included for a modulating burner with a pilot burner. These are connected to the valve outputs (terminals 13, 14 and 57). Valves V1 and V4 open to start the pilot burner. Gas valve V2 releases the gas supply to the main burner.

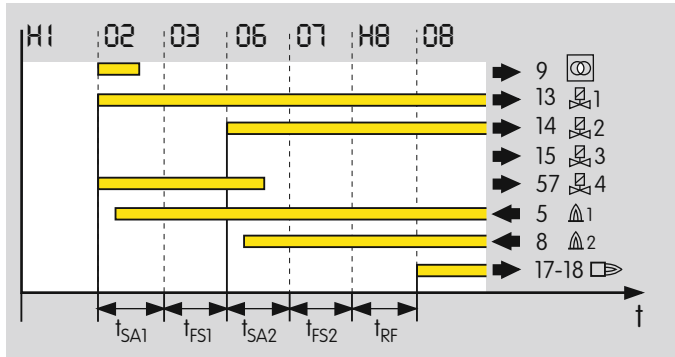
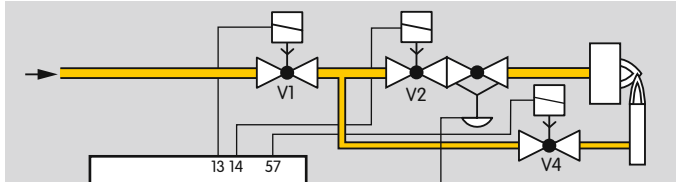

Parameter 78 = 3: burner 1 and burner 2 with pilot gas. In this application, the burner has an additional pilot gas valve V3. The valves are connected to the valve outputs (terminals 13, 14, 15 and 57). Valves V1 and V4 open to start the pilot burner. The burner is started with a limited ignition capacity using gas valve V3. After

the elapse of the safety time  $t_{SA2}$  (program step 06), valve V2 opens (terminal 14). Pilot gas valve V3 is closed again after the elapse of the flame proving period  $t_{FS2}$  (program step 07).

For this application, it must be ensured that the flame proving period (P97) is set to a value  $\geq 2$  s.

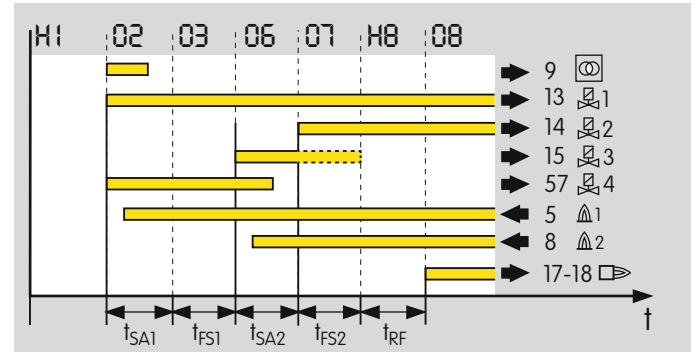
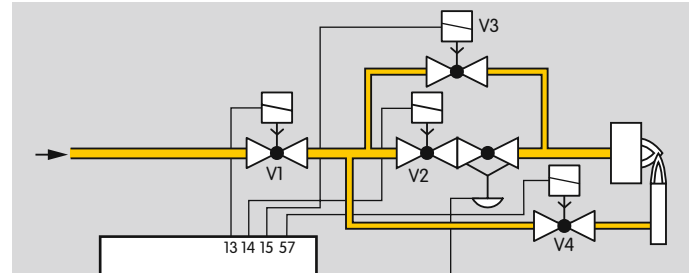

## Parameters

Parameter 78 = 4: two-stage burner 1. Three valves (V1, V2 and V3) are included for a two-stage-controlled burner. These are connected to the valve outputs (terminals 13, 14 and 15). The burner can be started with minimum capacity. When the operating state (program step 04) is reached, the BCU issues the Enable signal for the maximum burner capacity to gas valve V2.

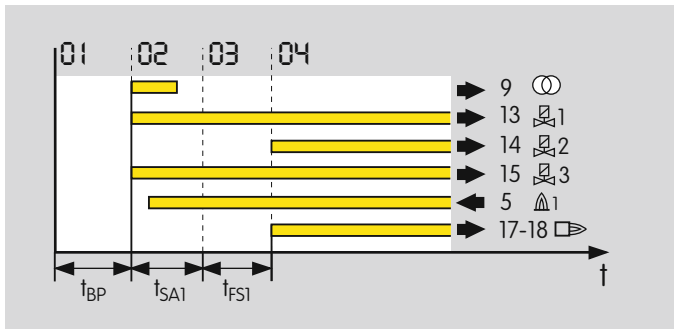
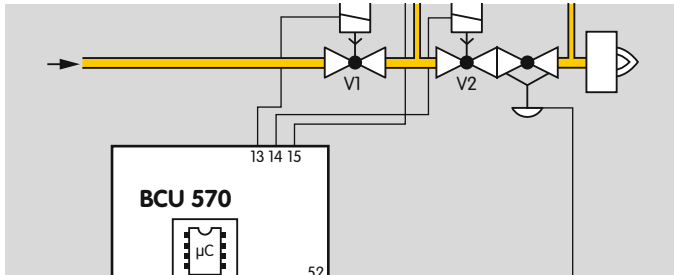

Parameter 78 = 5: burner 1 and two-stage burner 2. In this application, the burner has an additional pilot gas valve V3. The valves are connected to the valve outputs (terminals 13, 14, 15 and 57). Valves V1 and V4 open to start the pilot burner. The burner is started with a limited ignition capacity using gas valve V3. Valve V2 (terminal 14) can be opened with the operating signal (program step 08) in order to operate burner 2 at maximum capacity.

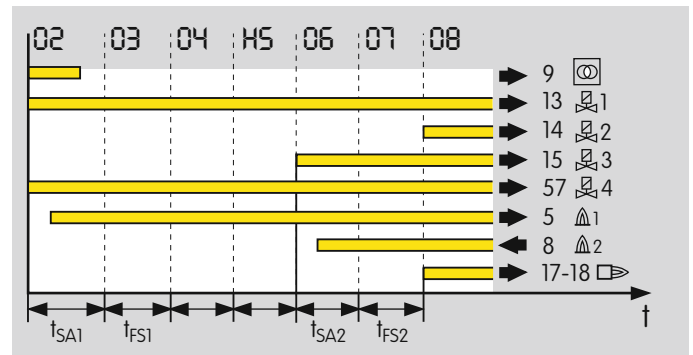
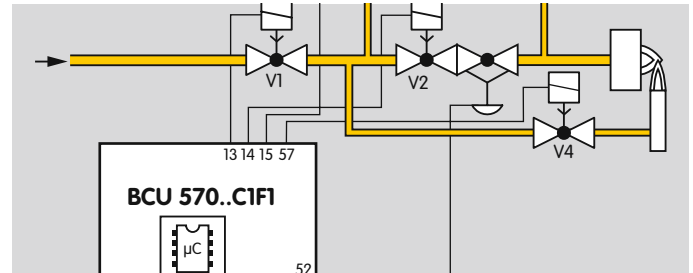

### 10.3.4 Safety time 1 $t_{SA1}$

Parameter 94

During the safety time 1  $t_{SA1}$ , the flame (pilot flame) is ignited. It can be set to 2, 3, 5 or 10 s.

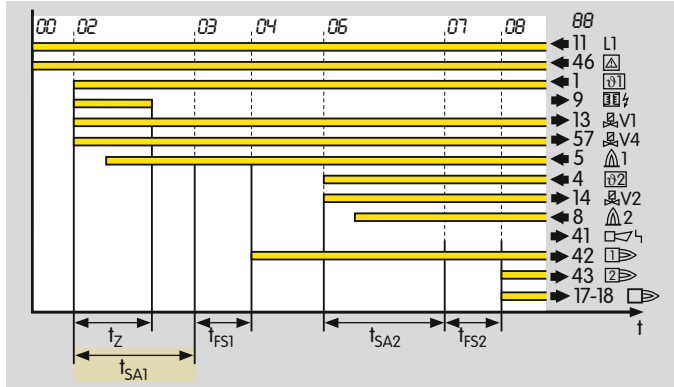

Safety time 1 starts with the application of the  $\varnothing 1$  signal (terminal 1). The valves open at the start of safety time 1. The fuel supply to burner 1 is released so that a flame can form. If no flame is detected at the end of safety time 1, the valves are closed again. Depending on parameter 07 (Burner 1 start-up attempts), the BCU reacts either with an immediate safety shut-down with fault lock-out (P07 = 1) or with one or two additional start-up attempts (P07 = 2 or 3). The BCU will complete a maximum of three start-up attempts.

Safety time 1 must be determined on the basis of current national standards and regulations. The burner application and the burner capacity are the main criteria for this.

If the  $\varnothing 1$  signal (terminal 1) drops out during safety time 1, the valves will not be switched off until the end of safety time 1.

### 10.3.5 Flame proving period 1 $t_{FS1}$

Parameter 95

Flame proving period 1 ( $t_{FS1}$ ) can be parameterized to enable the flame on burner 1 to stabilize after the elapse of safety time 1. Only when the flame proving period has elapsed will the next program steps be initiated by the BCU. The flame proving period can be set between 0 and 20 s.

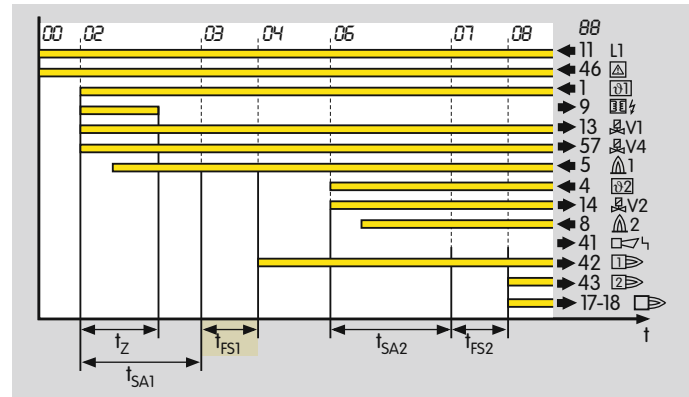

## 10.3.6 Safety time 2 $t_{SA2}$

Parameter 96

During the safety time 2  $t_{SA2}$ , the flame on burner 2 (main flame) is ignited. It can be set to 2, 3, 5 or 10 s.

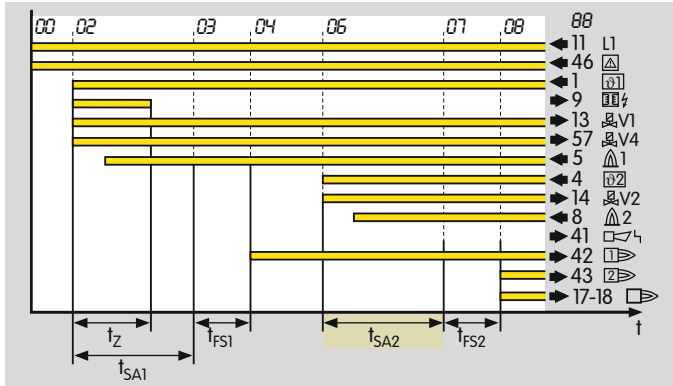

Safety time 2 starts with the application of the  $\varnothing 2$  signal (terminal 4). Valve V2 opens at the start of safety time 2. The fuel supply to burner 2 is released so that a flame can form. If no flame is detected at the end of safety time 2, the valves are closed again. Depending on parameter O8 (Burner 2 start-up attempts), the BCU reacts either with an immediate safety shut-down with fault lock-out (P08 = 1) or with one or two additional start-up attempts (P08 = 2 or 3). The BCU will complete a maximum of three start-up attempts.

Safety time 2 must be determined on the basis of current national standards and regulations. The burner application and the burner capacity are the main criteria for this.

If the  $\varnothing 1$  signal (terminal 1) drops out during safety time 2, the valves will not be switched off until the end of safety time 2.

## 10.3.7 Flame proving period 2 $t_{FS2}$

Parameter 97

Flame proving period 2  $t_{FS2}$  can be parameterized to enable the flame on burner 2 to stabilize after the elapse of safety time 2. Only when the flame proving period has elapsed will the next program steps be initiated by the BCU. The flame proving period can be set between 0 and 20 s.

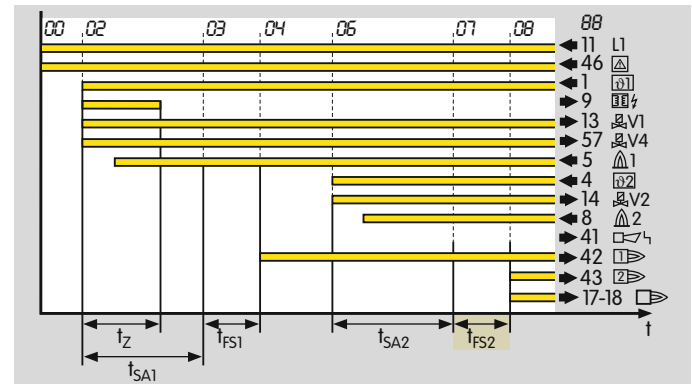

## 10.4 Behaviour during operation

### 10.4.1 Restart

#### Parameter 09

This parameter determines whether the BCU initiates an immediate safety shut-down with fault lock-out or an automatic restart after a flame failure during operation. Excessive restarts (max. 5) can also be detected.

In accordance with EN 746-2, a restart may be conducted only if the safety of the installation is not impaired. A restart is recommended for burners which occasionally display unstable behaviour during operation. The precondition for an automatic restart is that the burner can restart (as intended in all operating phases). In this case, it must be ensured that the program sequence started by the BCU matches the application.

Parameter 09 = 0: Off.

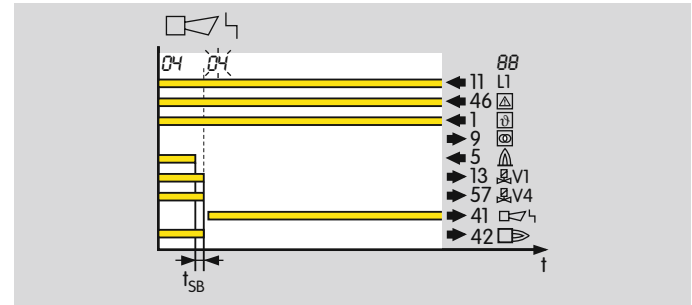

A safety shut-down with subsequent fault lock-out takes place in the event of flame failure during operation.

## Parameters

Parameter O9 = 1: burner 1. The restart function is active.

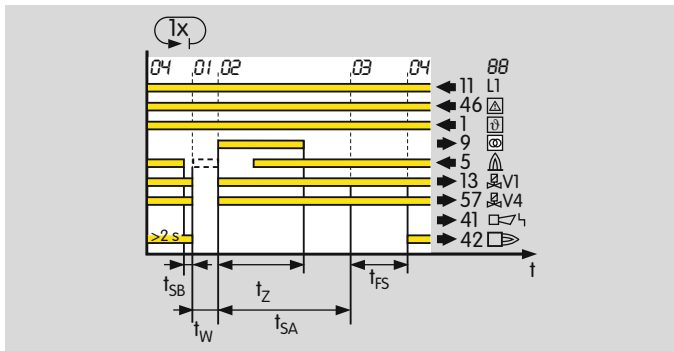

If a flame failure occurs during operation (minimum operating time of 2 s), the valves are closed and the operation signalling contact is opened within the safety time during operation  $t_{SB}$ . The burner control unit then attempts to restart the burner once. If the burner does not function, a safety shut-down with fault lock-out occurs. The display blinks and shows the fault message.

Parameter O9 = 2: burner 2.

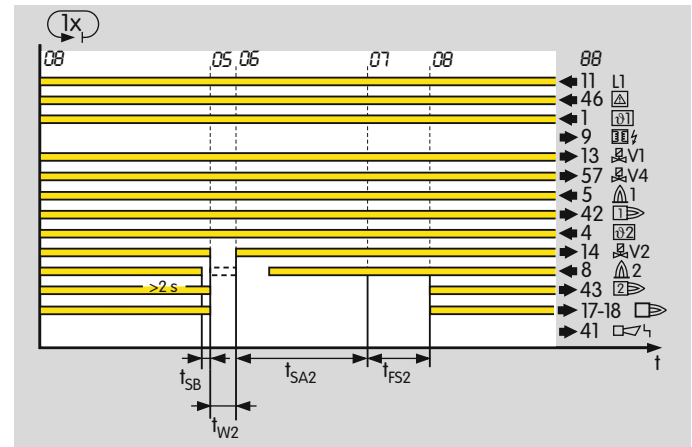

If a flame failure occurs during operation (minimum operating time of 2 s), valve 2 is closed and the operation signalling contact is opened within the safety time during operation  $t_{SB}$ . The burner control unit then attempts to restart burner 2 once. If burner 2 does not function, a safety shut-down with fault lock-out occurs. The display blinks and shows the fault message.

Parameter O9 = 3: burner 1 and burner 2.

## Parameters

---

Parameter 09 = 4: max. 5 × in 15 min. for burner 1. The restart function is active and is also monitored. In certain conditions, it is possible that the restart function is repeated continuously without a safety shut-down with subsequent fault lock-out being performed. The BCU has a safety shut-down with subsequent fault lock-out option if more than 5 restarts are performed within a period of 15 minutes.

**Taking into account national standards and requirements, it must be clarified whether the option may be used.**

Parameter 09 = 5: max. 5 × in 15 min. for burner 2.

Parameter 09 = 6: max. 5 × in 15 min. for burner 1 and 2.



### 10.4.2 Minimum operating time $t_B$

Parameter 61

A minimum operating time (0 to 250 s) may be defined to ensure that the heating equipment operates stably.

If the minimum operating time is active, burner operation will be maintained until the set time has elapsed even if the start-up signal fails.

The minimum operating time starts as soon as the program step for operation/controller enable (display  $\square B$ ) has been reached.

If the start-up signal drops out before the start of operation/controller enable, e.g. during pre-purge, the burner control unit reverts directly to the start-up position (standby) and the burner is not ignited.

The minimum operating time can be cancelled by switching off the BCU or if a safety shut-down occurs.

### 10.4.3 Pilot burner

Parameter 79

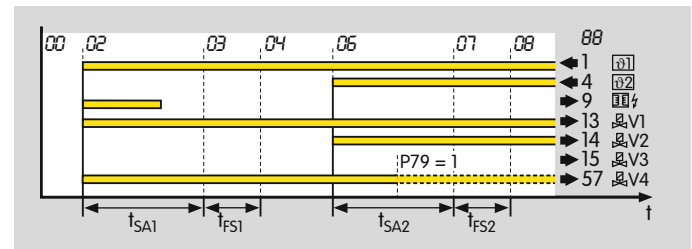

If a burner with a pilot burner is used, this parameter can be used to define whether the pilot burner is shut down 1 second before the end of the second safety time  $t_{SA2}$  or operates continuously.

Parameter 79 = 0: with shut-down.

Parameter 79 = 1: in continuous operation.

## 10.5 Safety limits

Parameter 19 can be used to adjust the safety limits (safety time during operation) to the system requirements.

### 10.5.1 Safety time during operation

Parameter 19

Parameter 19 = 1; 2: time in seconds.

The safety time during operation is the time that the BCU needs to stop the fuel supply after a flame failure during operation or an interruption at the safety current inputs (terminals 45 to 51 and 65 to 68). The safety time can be set to 1 or 2 s. Prolonging the safety time during operation increases the installation availability in the case of brief-duration signal fades (e.g. fades of the flame signal).

In accordance with EN 298, the maximum reaction time to a flame failure must not exceed 1 s. In accordance with EN 746-2, the safety time of the installation during operation (total closing time) may not exceed 3 s.

The requirements of national standards and regulations must be satisfied.

## 10.6 Air control

### 10.6.1 Capacity control

Parameter 40

The BCU is fitted with an interface for connecting air actuators.

The BCU..F1/F2 activates a control element via the outputs for capacity control (terminals 53 to 56) for purging, cooling or starting the burner. This control element moves to the required position for the relevant operating situation.

The BCU..F3 activates an air valve for purging, cooling or starting the burner via the output at terminal 10. The required air capacity is released by the air valve.

Using parameter 40, you can set which actuator is used for capacity control (actuators IC 20, IC 40, RBW or air valve).

Parameter 40 = 0: Off; no capacity control (no air actuator).

Parameter 40 = 1: with IC 20.

The interface is configured to the requirements of actuators IC 20, IC 20..E, IC 50 or IC 50..E.

Alternatively, comparable three-point step actuators may be used.

### IC 20

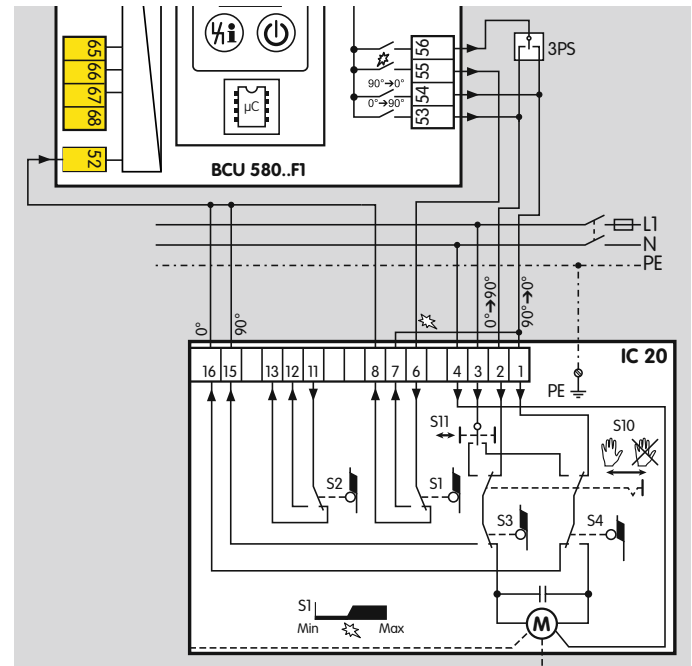

The positions for maximum capacity, ignition capacity and minimum capacity can be set using the actuator. It is checked whether the relevant position has been reached using terminal 52. If the position is not reached within the timeout time of 255 s, the BCU will display fault message  $R_C$ ,  $R_D$  or  $A_V$  (maximum, ignition or minimum capacity not reached), see page 51 (Fault signalling).

## Parameters

In the event of a fault, the actuator is moved to the position set via cam S4 for minimum capacity via the output at terminal 54.

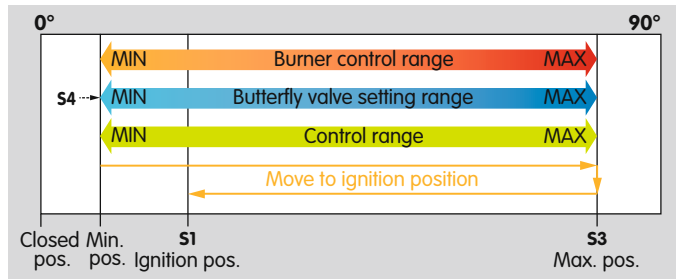

The control system is enabled for operation via the controller enable output (terminal 56). During the controller enable procedure, the actuator can be adjusted infinitely between the positions for maximum and minimum capacity by an external three-point step controller or using bus signals. There is no timeout active in this case.

If bus control is active (parameter 75), the controller enable output (terminal 56) has a different function. The wiring between the BCU and the 3-point step controller can be adjusted so that the control range of the actuator is between the positions for maximum and ignition capacity.

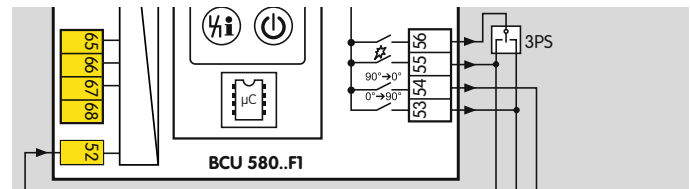

The minimum position which can be reached is the closed position.

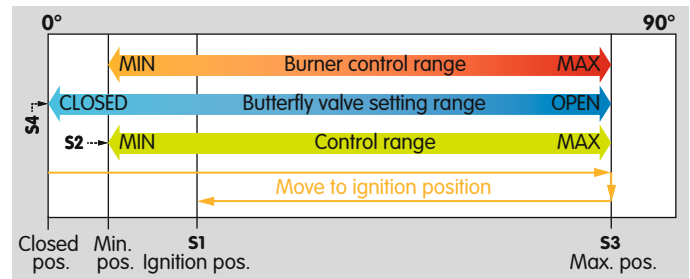

### Manual mode

In Manual mode, the actuator can be moved between the positions for maximum and minimum capacity in 3-point step operation. No timeout is active when approaching these positions. The controller enable output (terminal 56) is not active and not checked.

## IC 20..E

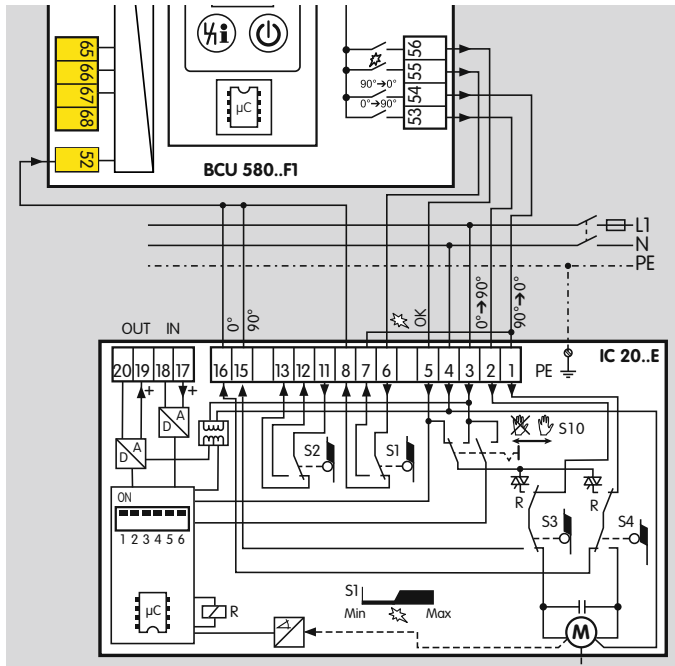

The positions for minimum capacity, maximum capacity and ignition capacity can be set using the actuator. When the appropriate position has been reached, this information is signalled back via terminal 52. If no signal is received that the position has been reached within the timeout time of 255 s, a safety shut-down of the BCU will be performed and a fault message ( $R_c$ ,  $R_D$  or  $R_i$ ) will be displayed, see page 51 (Fault signalling). In addition, the actuator will be moved to the set position for minimum capacity using the output at terminal 54.

The control system is enabled during operation via the controller enable output (terminal 56). During the controller enable procedure, the actuator can be adjusted infinitely between the positions for maximum and minimum capacity by a controller (0(4) – 20 mA, 0 – 10 V) using the setpoint device on terminals 17 and 18 or the bus signal. There is no timeout active in this case.

If bus control is active (parameter 75), the controller enable output (terminal 56) has a different function. The wiring between the BCU and the 3-point step controller can be adjusted so that the control range of the actuator is between the positions for maximum and ignition capacity.

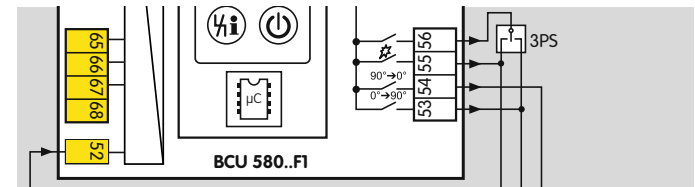

### Manual mode

In Manual mode, the actuator can be moved between the positions for maximum and minimum capacity in 3-point step operation. No timeout is active when approaching these positions. The controller enable output (terminal 56) is not active and not checked.

## IC 40

Parameter 40 = 2: with IC 40.

To ensure that the actuator IC 40 can be operated on the BCU..F1, P40 = 2 (capacity control) must be set. The operating mode of actuator IC 40 may be parameterized to 11 or 27.

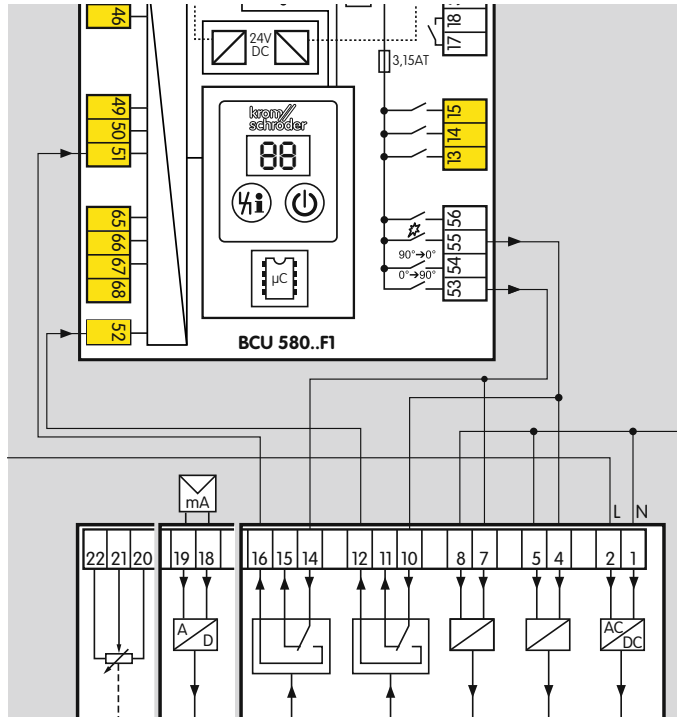

The positions for maximum capacity and ignition capacity can be set using the actuator. Terminal 51 checks whether the position for maximum capacity has

been reached. Terminal 52 checks the position for ignition capacity. If the position is not reached within the timeout time of 255 s, a safety shut-down of the BCU will be performed. A fault message ( $R_C$ ,  $R_D$  or  $R_I$ ) will be displayed, see page 51 (Fault signalling).

If a controller enable is active, the control system is enabled for operation via the outputs at terminals 53 and 55.

### Operating mode 11

Operating mode 11 allows cyclic operation (ON/OFF and OFF/Low/High/OFF).

The actuator IC moves to the “High fire” position during the controller enable procedure. There is no timeout active in this case.

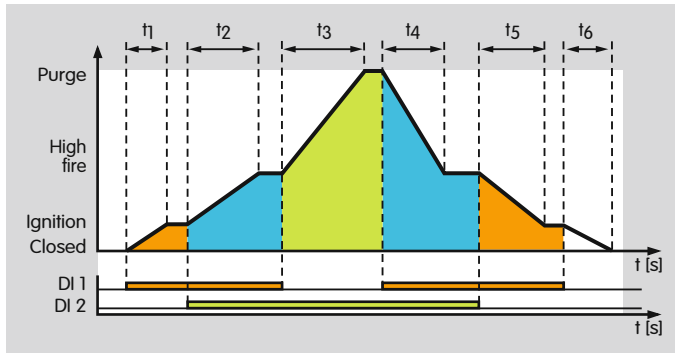

BCU		IC 40 (operating mode 11)	
Signal at terminal		Position	Butterfly valve position
<b>55</b>	<b>53</b>		
OFF	OFF	Closed	Closed
ON	OFF	Ignition	Minimum/Ignition capacity
ON	ON	High-fire rate	High-fire rate
OFF	ON	Purge	Maximum capacity

### Operating mode 27

During the controller enable procedure, the actuator IC 40 can be adjusted infinitely between the positions for maximum and minimum capacity using its analogue input (terminals 18 and 19). There is no timeout active in this case.

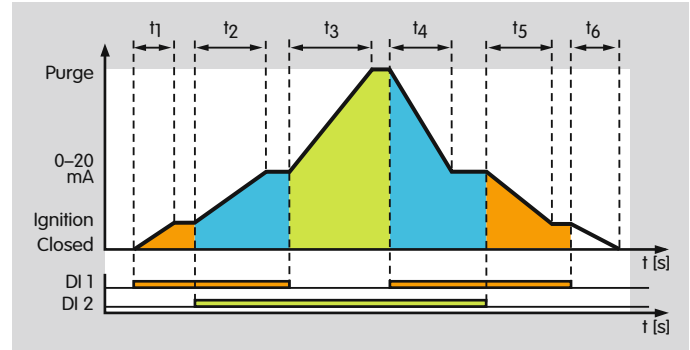

BCU		IC 40 (operating mode 27)	
Signal at terminal		Position	Butterfly valve position
<b>55</b>	<b>53</b>		
OFF	OFF	Closed	Closed
ON	OFF	Ignition	Minimum/Ignition capacity
ON	ON	0 – 20 mA	Any position between minimum and maximum capacity
OFF	ON	Purge	Maximum capacity

### **Fault**

In the event of a fault, there will be no signal at terminals 53 and 55 so that the actuator moves to the closed position. When approaching the closed position, no timeout of 255 s is active since no feedback input is checked. This may result in a situation where the program is continued in the case of a request for the closed position, without the butterfly valve being closed. The outputs at terminals 56 (controller enable) and 54 (closed position) on the BCU are non-functional and are not activated.

### **Manual mode**

In Manual mode, no external controller is enabled. The actuator can be moved to the positions for maximum capacity or ignition capacity by the user. 3-point step operation is not possible. No timeout is active when approaching these positions.



## RBW

Parameter 40 = 3: with RBW.

The actuator can be moved to the positions for maximum capacity (contact COM to HI) and minimum capacity (contact COM to LO) using the interface and by closing the various contacts.

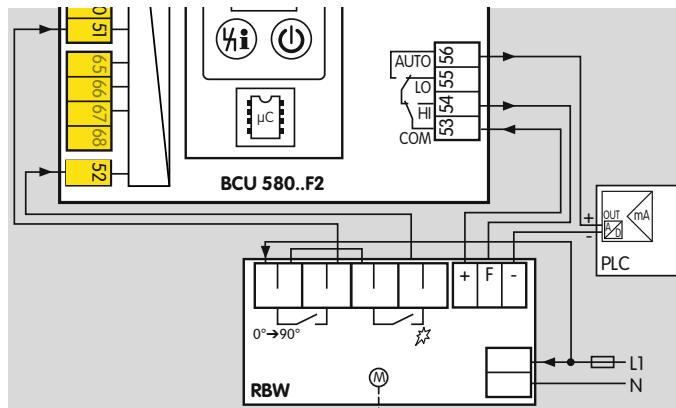
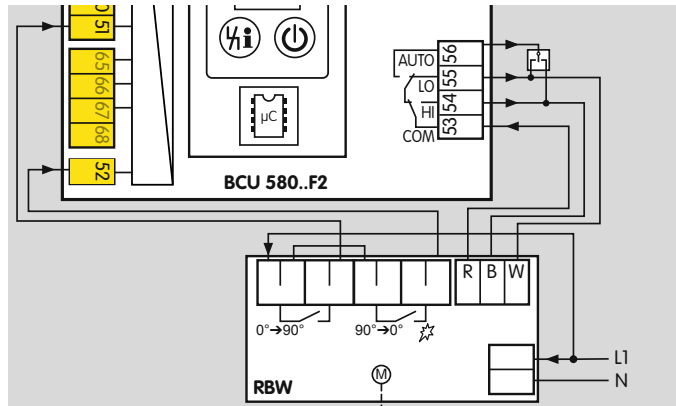

The RBW actuator reports that it has reached the position for maximum capacity via a signal to terminal 51. The actuator reports that it has reached the position for minimum capacity via a signal to terminal 52. The simultaneous activation of terminals 51 and 52 results in a fault lock-out of the BCU.

If parameter 41 = 0, the system monitors the movement to the positions for maximum and minimum capacity with a timeout time of 255 s. Reaching the relevant position immediately triggers the program continue switch conditions. If reaching the position is not signalled within the timeout time of 255 s, a safety shut-down of the BCU will be performed. A fault message ( $R_c$  or  $R_D$ ) will be displayed, see page 51 (Fault signalling).

If parameter 41 = 1, the system does not monitor whether the positions for minimum and maximum capacity are reached. In this case, a running time of up to 250 s must be defined using parameter 42, see page 84 (Running time). The program continue switch conditions are then controlled dependent on this time.

If a fault occurs, the actuator is moved to the position for minimum capacity.

### **Manual mode**

In Manual mode, no external controller is enabled during the controller enable procedure. The actuator can be moved to the positions for maximum capacity or ignition capacity by the user. 3-point step operation is not possible. No timeout is active when approaching these positions.

## Parameters

Parameter 40 = 5: with air valve.

The positions for maximum capacity and ignition capacity can be set using the air valve. If the air valve is closed, the ignition capacity is reached, if it is open, the maximum capacity is reached.

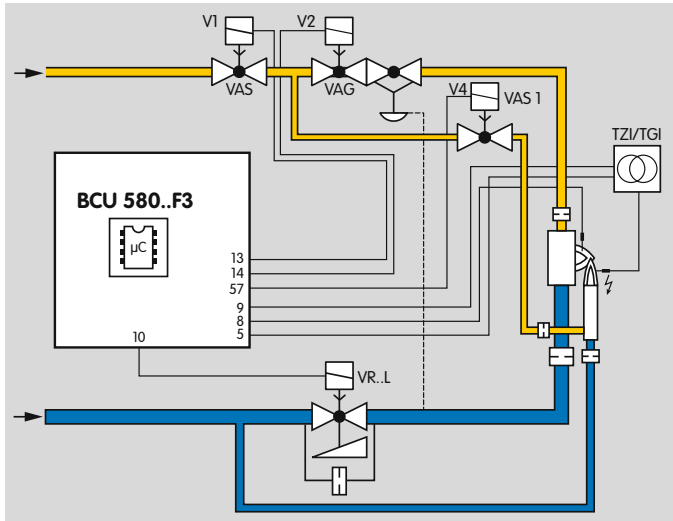

Parameter 42 (Running time) can be used to adjust the behaviour of slow opening and closing air valves so that the system can be set to ignition position before a start-up is initiated. Parameter 41 (Running time selection) must be set to 1 to adjust this behaviour.

See page 84 (Running time) and (84 (Running time selection)).

### 10.6.2 Running time selection

#### Parameter 41

Parameter 41 = 0: Off; checking the positions for minimum/maximum capacity. A signal that the positions for minimum and maximum capacity have been reached is returned and monitored with a timeout time of max. 255 s. When the position has been reached, the BCU will initiate the next program step.

Parameter 41 = 1: On; for approaching the positions for minimum/maximum capacity. The Running time set using parameter 42 is activated for approaching these positions. After this time has elapsed, the BCU will initiate the next program step.

Parameter 41 = 2: On; for approaching the position for maximum capacity. The Running time set using parameter 42 is activated for approaching the position for maximum capacity. After this time has elapsed, the BCU will initiate the next program step. Approaching the position for minimum capacity is signalled and monitored.

Parameter 41 = 3: On; for approaching the position for minimum capacity. No signal is returned that the position for minimum capacity has been reached. The Running time set using parameter 42 is activated for approaching the position for minimum capacity. After this time has elapsed, the BCU will initiate the next program step. Approaching the position for maximum capacity is signalled and monitored.

### 10.6.3 Running time

#### Parameter 42

This parameter can be used to adjust the behaviour of slow opening and closing air valves. The running time starts when the air actuator is switched off. A restart of the burner after a controlled shut-down, a start-up attempt, restart, cooling or purging is delayed until the end of the running time. After the running time has elapsed, the burner is started if the start-up signal (0) is applied.

The time should be adjusted such that the system can be set to ignition position, i.e. that the air actuator is closed before a start-up is initiated.

## 10.6.4 Low fire over-run

### Parameter 43

The low fire over-run ( $t_{KN}$ ) is applicable to systems with a pneumatic air/gas ratio control system and On/Off control. Using the low fire over-run function reduces the  $O_2$  content in the furnace atmosphere.

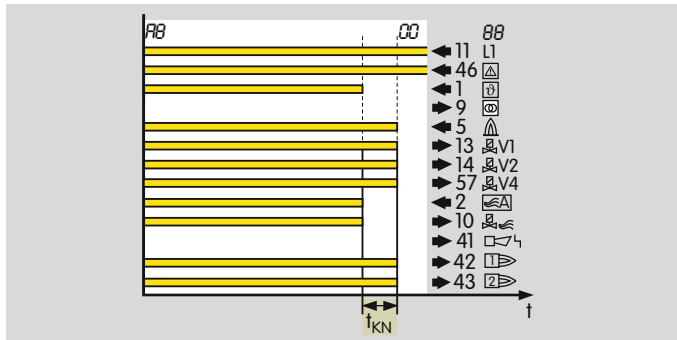

Parameter 43 = 0: Off. No low fire over-run is performed. The gas circuit is closed immediately owing to a quick closing gas valve in the case of On/Off control. The air circuit is closed more slowly. The air flowing in during this time increases the  $O_2$  content in the combustion chamber.

Parameter 43 = 1 (only for BCU..F1/F2): up to minimum capacity. The burner is not immediately switched off after the start-up signal  $\vartheta$  (terminal 1) has been removed. During low fire over-run, the control element is moved to the position for minimum capacity and the gas valves remain open until the flame fails or the position for min-

imum capacity is reached. If the flame is extinguished, this does not result in a fault.

Parameter 43 = 2, 3, 4, 5, 10, 20, 30 or 40 (only for BCU..F3): time in seconds. During this time, the gas valve remains open. The air valve is closed with deactivated start-up signal ( $\vartheta$ ).

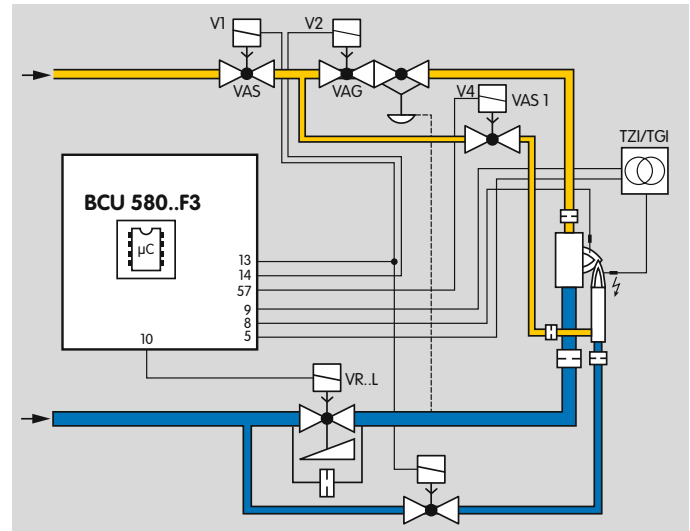

This means that the burner is initially adjusted down to low fire and then switched off completely. Flame control is still operational. It must be ensured that no excess gas occurs.

### 10.6.5 Controller enable signal delay time $t_{RF}$

Parameter 44 (only on BCU..F1/F2)

The controller enable signal is delayed by 0, 10, 20 or 30 up to 250 s using parameter 44.

If the BCU has successfully started the burner, after the elapse of the safety time and the flame proving period, if parameterized, the controller enable signal to the external temperature controller is delayed. The BCU shows program status *HB*. After the elapse of the delay time  $t_{RF}$ , the burner operation signalling contact (terminals 17, 18) is closed and the controller enable output (terminal 56) activated. The display changes to *00*.

### 10.6.6 Air actuator control

Parameter 48

In cyclic operation, parameters 48 and 49 on BCU..F1, F2 and F3 determine the behaviour of the air actuator during burner start.

Parameter 48 = 0: opens on external activation.

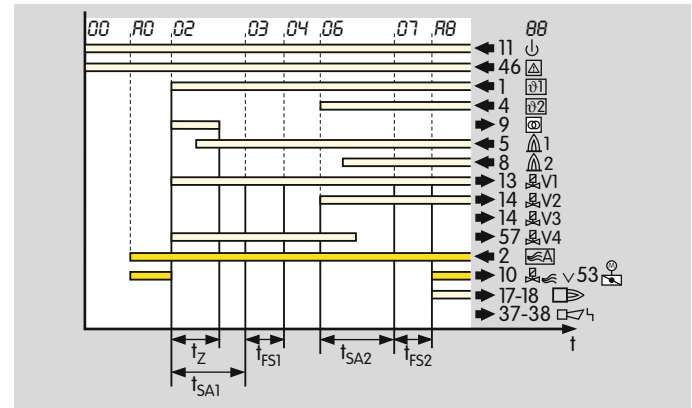

This setting together with parameter 49 = 0, see page 89 (Air actuator can be activated externally on start-up), is required for burners on which the air/gas ratio is controlled by a pneumatic air/gas ratio control system and which need to be started at low-fire rate, e.g. on two-stage-controlled burners, see page 11 (Two-stage-controlled main burner with permanent pilot burner). In this case, activation of the air actuator during burner start via the input at terminal 2 must be prevented.

External control allows switchover between low fire and high fire during operation.

## Parameters

Parameter 48 = 1: opens with gas stage 1.

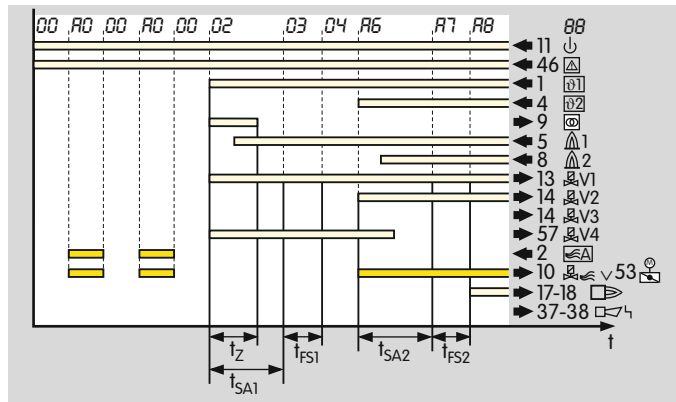

The air actuator opens at the same time as safety time  $t_{SA2}$  begins and the main burner starts.

Parameter 48 = 2: opens with operating signal.

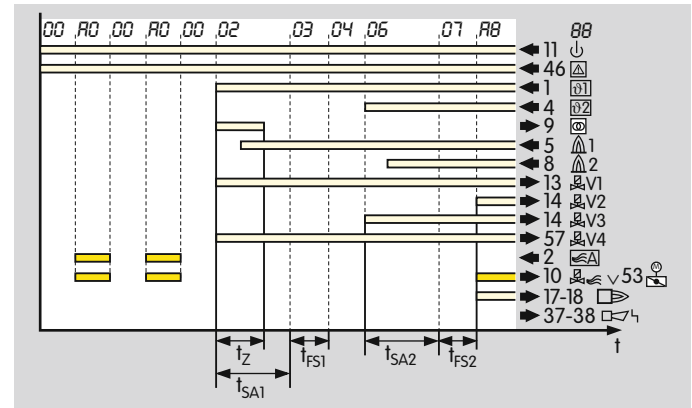

This setting is required in the case of two-stage main burners which are switched ON/OFF via the  $\varnothing 2$  input. The air valve opens simultaneously with the operating signal for the main burner. The air valve can be activated externally via the input at terminal 2 for cooling the burner in the start-up position/standby. This function is not available during burner start-up and during operation.

## Parameters

Parameter 48 = 3: controller enable following operating signal or in standby.

This parameter is used to activate modulating capacity control on BCU..F1 and F2. The controller enable signal is issued via the output at terminal 56 in the start-up position (standby) and during operation.

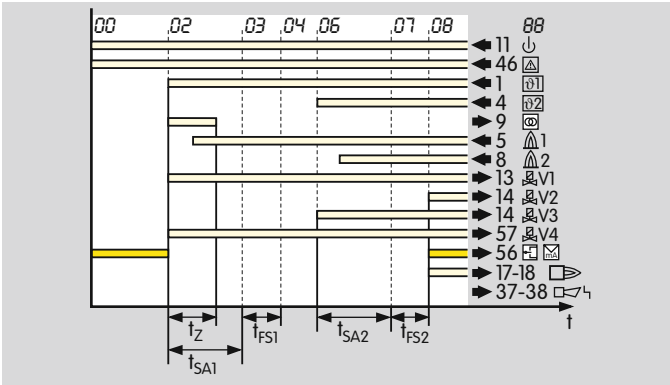

The air actuator can be opened in standby via the input at terminal 2 for this purpose. Cooling is then only possible in the start-up position/standby. The controller enable signal is suspended during cooling.

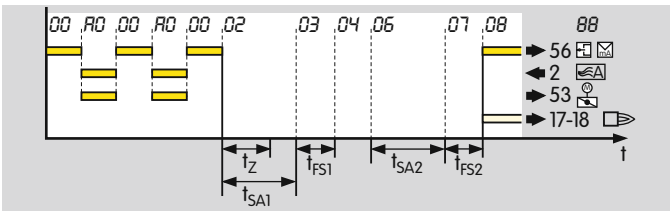

Parameter 48 = 4: opens with V4 pilot burner.

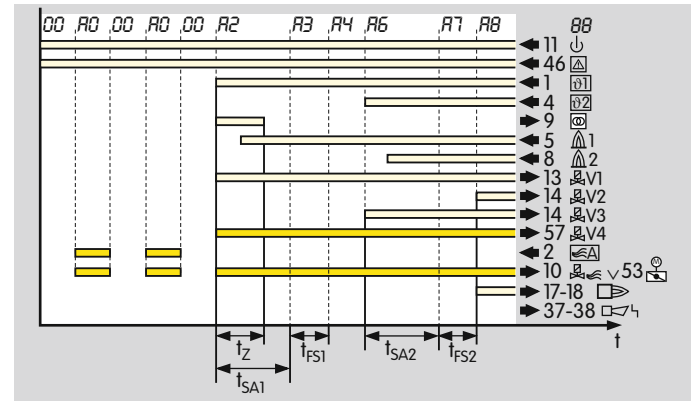

The air valve opens with the start-up fuel rate. The air valve can be activated externally via the input at terminal 2 for cooling the burner in the start-up position/standby.



### 10.6.7 Air actuator can be activated externally on start-up

Parameter 49

Parameter 49 = 0: cannot be activated.

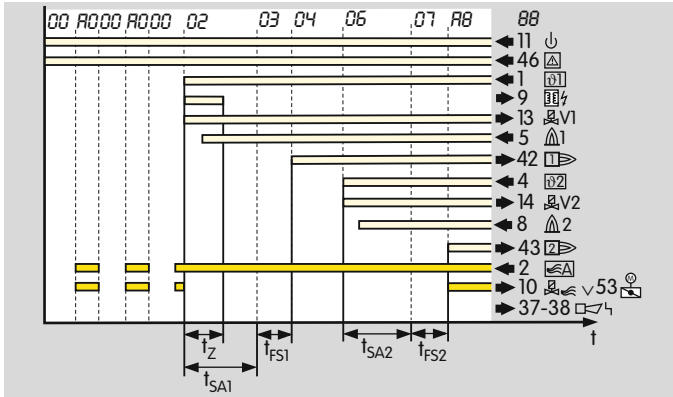

During start-up, the air actuator remains closed. The air actuator cannot be activated externally.

Parameter 49 = 1: can be activated externally.

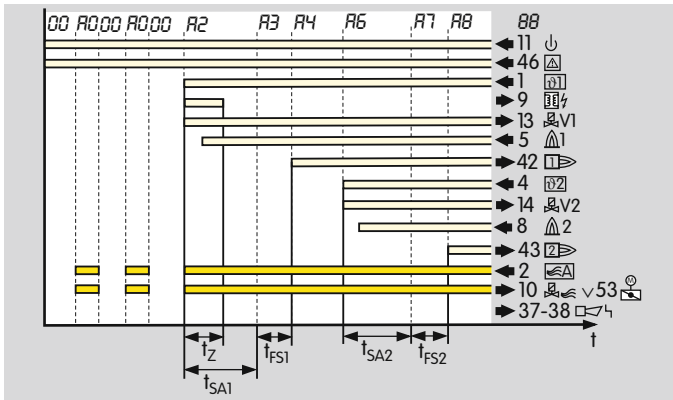

The air actuator can be activated externally via the input at terminal 2 during start-up. Parameter 48 must be set to 0 for this purpose, see also page 86 (Air actuator control).

### 10.6.8 Air actuator in the event of fault

Parameter 50

This parameter decides whether the air actuator can be activated externally via the input at terminal 2 in the event of a fault lock-out.

Parameter 50 = 0: cannot be activated. The air actuator remains closed in the event of a fault lock-out. It cannot be activated externally via the input at terminal 2.

Parameter 50 = 1: can be activated externally. The air actuator can be activated externally via the input at terminal 2 during a fault, e.g. for cooling.

## 10.6.9 Capacity control (bus)

### Parameter 75

Controlling the burner capacity using the fieldbus is only possible with bus module BCM 500 connected and enabled (P80 = 1 or 2).

The output at terminal 56 has a different function.

Parameter 75 = 0: Off. No capacity control possible using the fieldbus.

Parameter 75 = 1: MIN. to MAX. capacity; standby in position for MIN. capacity. The control range while the burner is operating is between the positions for minimum capacity (S4) and maximum capacity (S3). The burner is ignited in the position for ignition capacity (S1). When the burner is switched off, the actuator is moved to the position for minimum capacity (S4).

This operating mode can be achieved with an actuator IC 20, RBW or alternatively with a comparable three-point step actuator.

**If the air supply is stopped on a heated furnace with the burner switched off, the controls may be damaged by the hot furnace atmosphere as a result of the lowest possible position of the butterfly valve, limited by S4.**

### IC 20

Switching cam setting for ignition capacity, minimum and maximum capacity as well as pre-purge and standby:

S1: for ignition capacity of the burner.

S3: for maximum capacity of the burner and pre-purge.

S4: for minimum capacity of the burner and standby.

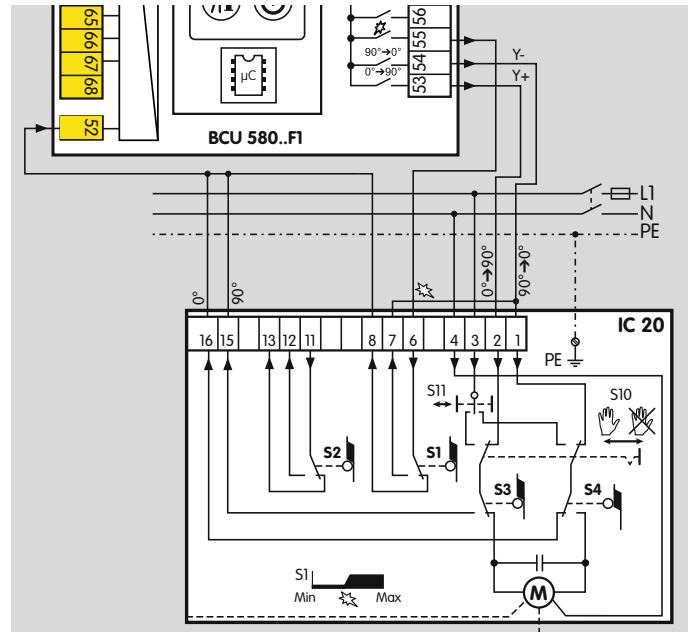
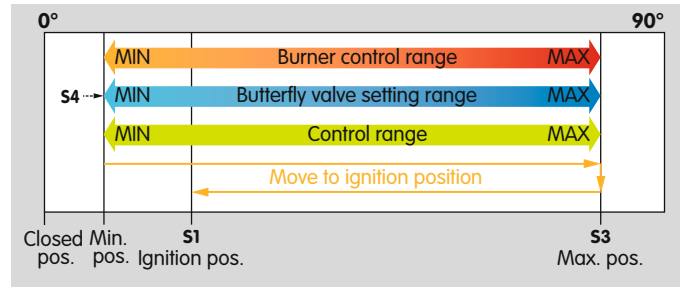

## Parameters

Parameter 75 = 2: MIN. to MAX. capacity; standby in CLOSED position. The control range while the burner is operating is between the positions for minimum capacity (S2) and maximum capacity (S3). The burner is ignited in the position for ignition capacity (S1). When the burner is switched off, the actuator is moved to the closed position (S4).

This operating mode can be achieved with an actuator IC 20 or alternatively with a comparable three-point step actuator.

**If the air supply is stopped on a heated furnace with the burner switched off, the controls are protected from the hot furnace atmosphere as a result of the butterfly valve being in the closed position (limited by S4). Check whether the burner can cope without cooling in this situation.**

### IC 20

Switching cam setting for ignition capacity, minimum and maximum capacity as well as pre-purge and standby:

- S1: for ignition capacity of the burner.
- S2: for minimum capacity of the burner.
- S3: for maximum capacity of the burner and pre-purge.
- S4: for the closed position of the butterfly valve and standby.

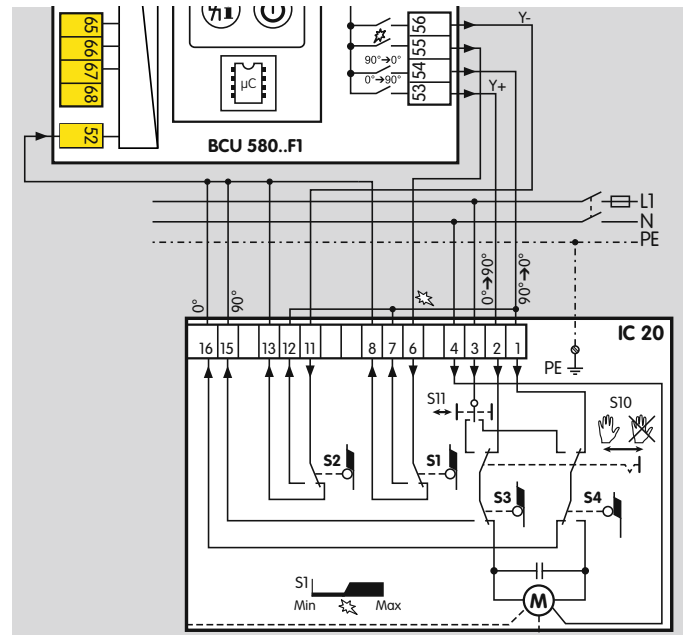
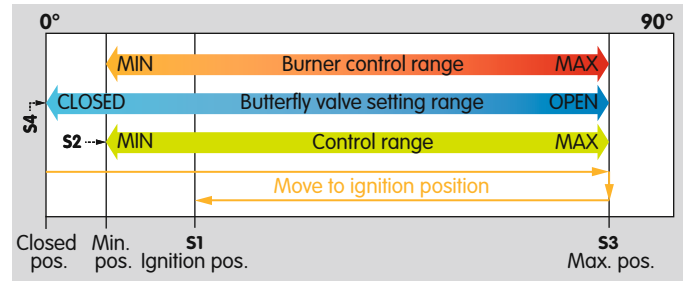

## Parameters

Parameter 75 = 3: IGNITION to MAX. capacity; standby in CLOSED position.

The control range while the burner is operating is between the positions for minimum capacity (S1) and maximum capacity (S3). The burner is ignited in the position for minimum capacity (S1). When the burner is switched off, the actuator is moved to the closed position (S4).

This operating mode can be achieved with an actuator IC 20, RBW or alternatively with a comparable three-point step actuator.

**If the air supply is stopped on a heated furnace with the burner switched off, the controls are protected from the hot furnace atmosphere as a result of the butterfly valve being in the closed position (limited by S4). Check whether the burner can cope without cooling in this situation.**

### IC 20

Switching cam setting for ignition capacity, minimum and maximum capacity as well as pre-purge and standby:

S1: for minimum capacity and ignition capacity of the burner.

S3: for maximum capacity of the burner and pre-purge.

S4: for the closed position of the butterfly valve and standby.

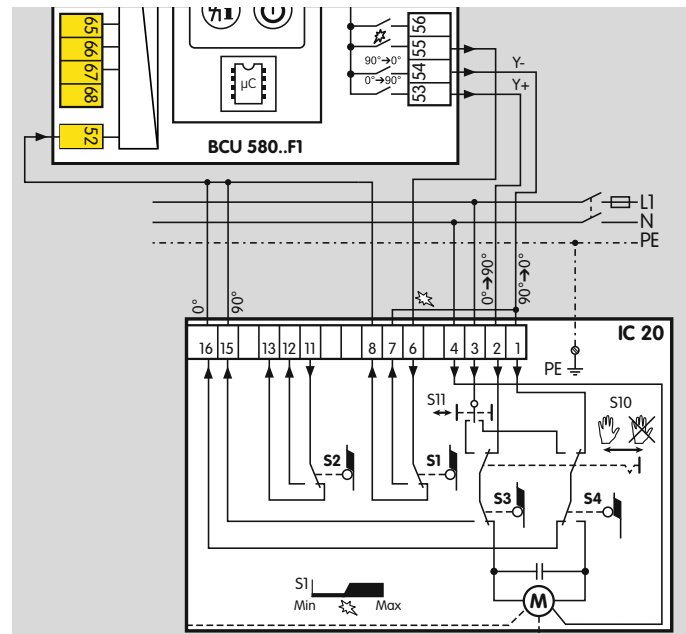
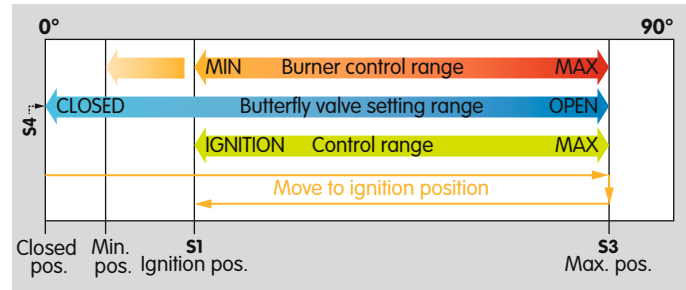

## Parameters

Parameter 75 = 4: MIN. to MAX. capacity; standby in position for MIN. capacity; burner quick start.

The control range while the burner is operating is between the positions for minimum capacity (S4) and maximum capacity (S3). The burner is ignited in the position for ignition capacity (S1). Switching cam S2 (reverse direction of rotation) ensures that the position for ignition capacity is approached without pre-purging first (quick start). When the burner is switched off, the actuator is moved to the position for minimum capacity (S4).

This operating mode can be achieved with an actuator IC 20 or alternatively with a comparable three-point step actuator.

**If the air supply is stopped on a heated furnace with the burner switched off, the controls may be damaged by the hot furnace atmosphere as a result of the lowest possible position of the butterfly valve, limited by S4. If pre-purge is active, considerably lower air capacity than the maximum air capacity will be used for purging.**

### IC 20

Switching cam setting for ignition capacity, minimum and maximum capacity and reverse direction of rotation to approach the position for ignition capacity:

S1: for ignition capacity of the burner.

S2: for reversing the direction of rotation to approach the position for ignition capacity.

S3: for maximum capacity of the burner and pre-purge.

S4: for the closed position of the butterfly valve and standby.

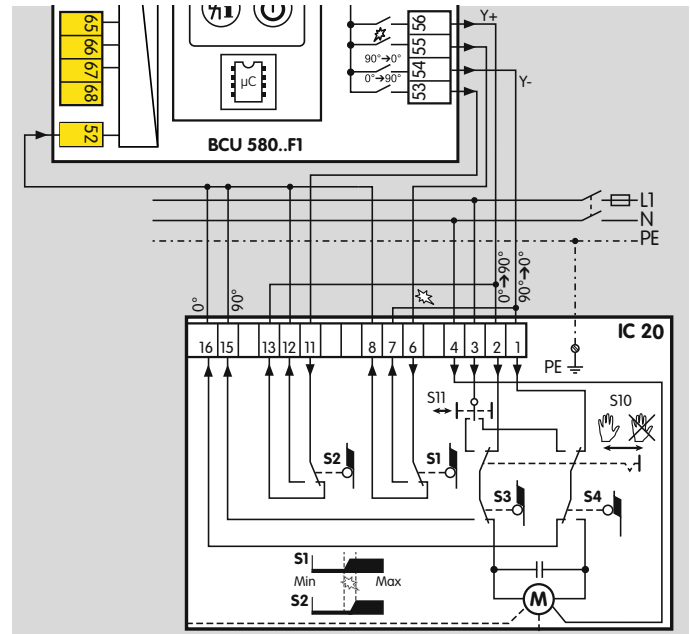
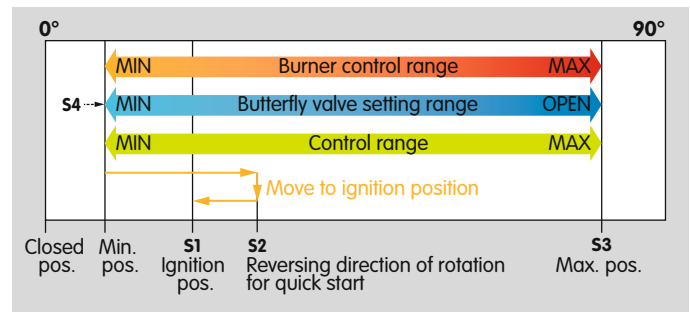

## Parameters

Parameter 75 = 5: IGNITION to MAX. capacity; standby in CLOSED position; burner quick start.

The control range while the burner is operating is between the positions for ignition capacity (S1) and maximum capacity (S3). The burner is ignited in the position for ignition capacity (S1). Switching cam S2 (reverse direction of rotation) ensures that the position for ignition capacity is approached without pre-purging first (quick start). When the burner is switched off, the actuator is moved to the closed position (S4).

This operating mode can be achieved with an actuator IC 20 or alternatively with a comparable three-point step actuator.

**If the air supply is stopped on a heated furnace with the burner switched off, the controls are protected from the hot furnace atmosphere as a result of the butterfly valve being in the closed position (limited by S4). Check whether the burner can cope without cooling. If pre-purge is active, considerably lower air capacity than the maximum air capacity will be used for purging.**

### IC 20

The position for maximum capacity is achieved by the controller enable output (terminal 56).

Switching cam settings S1, S2, S3 and S4:

S1: for minimum capacity and ignition capacity of the burner.

S2: for reversing the direction of rotation to approach the position for ignition capacity without reaching the position for maximum burner capacity.

S3: for maximum capacity of the burner and pre-purge.

S4: for the closed position of the butterfly valve and standby.

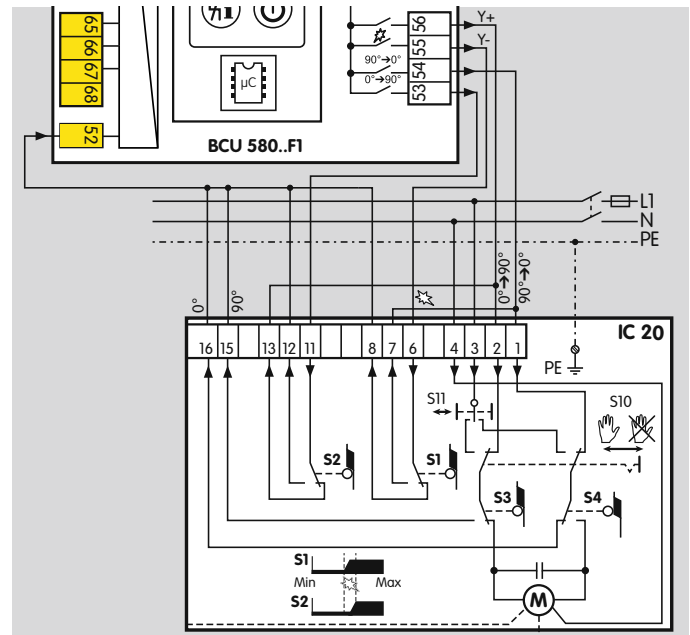
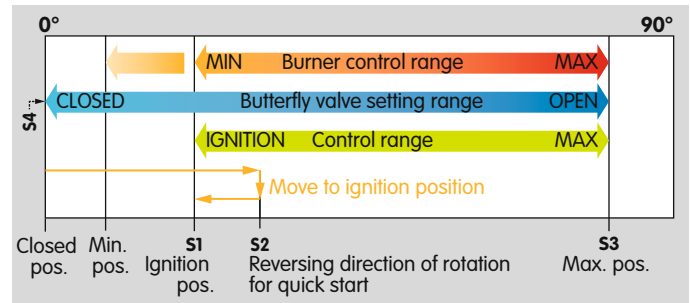

### 10.7 Valve check

#### 10.7.1 Valve proving system

##### Parameter 51

Parameter 51 is used to define whether and at what time in the BCU program sequence the valve check is activated. This allows either the tightness of the gas solenoid valves and the pipework between them to be checked (tightness test) or the closed position of a solenoid valve (proof of closure function) to be checked. If the proof of closure function is activated, the closed position of the gas solenoid valve at the inlet side is checked using a POC switch.

Parameter 51 = 0: Off. No valve check is activated.

Parameter 51 = 1: tightness test before start-up.

Parameter 51 = 2: tightness test after shut-down. With this setting, a tightness test is also performed after a fault is reset and after mains on.

Parameter 51 = 3: tightness test before start-up and after shut-down.

An additional bypass valve must be installed in gas sections with an air/gas ratio control. The valve allows the closed air/gas ratio control to be bypassed during the tightness test.

Parameter 51 = 4: proof of closure function (POC).

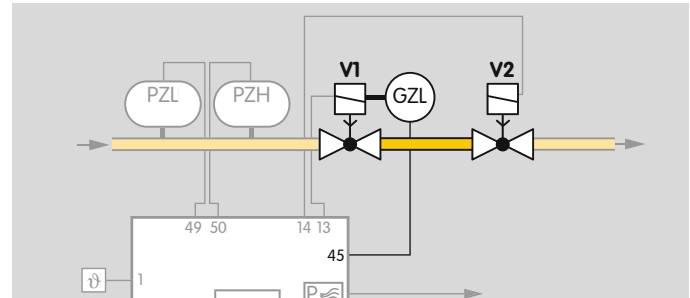

A signal is sent to the BCU via the POC switch on the gas solenoid valve on the inlet side before burner start-up stating that the valve is closed. After burner start-up, the signal must drop out to indicate to the BCU that the valve is open.

### 10.7.2 Relief valve (VPS)

Parameter 52

One of the valves connected to terminal 14, 15 or 57 can be selected to discharge the test volume during a tightness test.

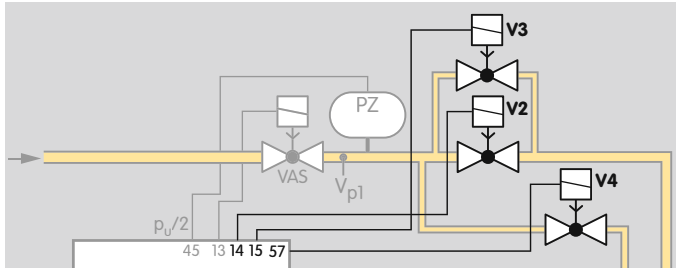

Parameter 52 = 2: V2. The test volume is discharged via the valve connected to terminal 14.

Parameter 52 = 3: V3. The test volume is discharged via the valve connected to terminal 15.

Parameter 52 = 4: V4. The test volume is discharged via the valve connected to terminal 57.

### 10.7.3 Measurement time $V_{p1}$

Parameter 56

The required measurement time must be determined according to the requirements of the appropriate application standards, e.g. EN 1643.

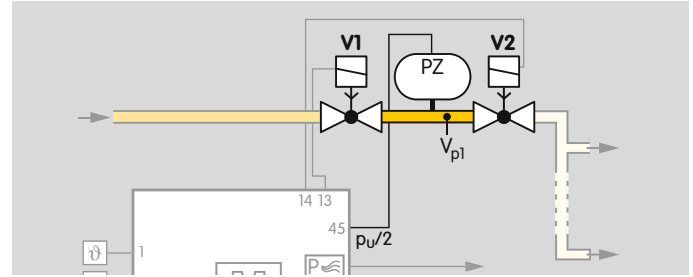

The required measurement time for the tightness test of  $V_{p1}$  can be set using parameter 56. The possible settings are 3 s, 5 to 25 s (in 5 s steps) or 30 to 3600 s (in 10 s steps).

See also page 33 (Measurement time  $t_M$ ).



### 10.7.4 Valve opening time 1 $t_{L1}$

Parameter 59

This parameter is used to define the opening time for the valves (2 to 25 s) which are opened to fill or discharge the test volume between the gas valves. If the preset opening time  $t_L = 2$  s is inadequate (e.g. if slow opening valves are used) to fill the test volume or reduce the pressure between the valves, bypass valves can be used instead of the main valves.

The opening time may be longer than the 3 s permitted by the standard (EN 1643:2000) if

- the gas volume which flows into the combustion chamber is equal to, or less than, 0.083 % of the maximum flow rate  
and
- if bypass valves are used.

## 10.8 Behaviour during start-up

### 10.8.1 Minimum pause time $t_{BP}$

Parameter 62



A minimum pause time  $t_{BP}$  (0 to 3600 s) can be defined to achieve stable operation of the burners.

If a signal is applied to terminal 1 (burner start-up) or terminal 2 (cooling) during the minimum pause time, status display Delay  will appear.

### 10.9 Manual mode

If the Reset/Information button is pressed for 2 s during switch-on, the BCU reverts to Manual mode. Two dots blink on the display. The BCU is now operating in Manual mode independently of the status of the inputs of the burner 1 start-up signal (terminal 1), controlled air flow (terminal 2), remote reset (terminal 3) and the burner 2 start-up signal (terminal 4). The functions of the safety-relevant inputs such as controller enable/emergency stop (terminal 46) are retained. The manual start-up of the BCU can be initiated in Manual mode by pressing the Reset/Information button. Each time the button is pressed again, the BCU moves to the next step of the program sequence and stops there, for example for adjusting an actuator or the gas/air mixture.

#### Actuator IC 20, IC 40 and RBW

Following controller enable (status display ) , a connected actuator can be opened and closed as required. By holding the button, the actuator is first opened further. The BCU indicates  with blinking dots. Once the button has been released, the actuator stops in the relevant position. Pressing it again will result in closing the actuator to the position for minimum capacity. The BCU indicates  with blinking dots. A change of direction takes place each time the button is released and pressed again. When the actuator has reached its final position, the dots disappear.

#### 10.9.1 Operating time in Manual mode

Parameter 67

Parameter 67 determines when Manual mode is terminated.

Parameter 67 = 0: Manual mode is not limited in time.

If this function has been selected, operation of the burner may be continued manually in the event of failure of the control system or the bus activation.

Parameter 67 = 1: the BCU will terminate Manual mode 5 minutes after the last time the button is pressed. It then moves abruptly back to the start-up position (standby).

If the unit is switched off or a power failure occurs, Manual mode on the BCU will be terminated regardless of parameter 67.

### 10.10 Functions of terminals 50, 51, 65, 66, 67 and 68

The BCU is informed via terminal 50 by a separate automation system that purging is currently being performed.

Terminals 51, 65, 66, 67 and 68 can each be assigned a logical AND gating with one of the inputs for the safety functions (terminals 46 – 50) using an appropriate parameter. If AND gating is required, the input concerned can be enabled.

Terminal 51 can also be used as a feedback input for the maximum capacity position when operated with IC 40/RBW.

#### 10.10.1 Function of terminal 50

Parameter 68

The BCU..F1, F2 or F3 supports centrally-controlled pre-purge or post-purge. In the case of multiple burner applications, burners with mechanical combustion air supply are used. The air for combustion and pre-ventilation is supplied by a central fan controlled by a separate automation system. The automation system sends a signal to terminal 50 during purging. At this point, the BCU opens the air actuator (actuator, air valve) regardless of the status of the other inputs. The display shows P 0.

Parameter 68 = 23: purge with Low signal.

Parameter 68 = 24: purge with High signal.

#### 10.10.2 Function of terminal 51

Parameter 69

Parameter 69 = 0: Off.

Parameter 69 = 8: AND with input at terminal 46 (emergency stop).

Parameter 69 = 13: Max. capacity position feedback (IC 40/RBW), see page 81 (Parameter 40 = 3: with RBW.).

#### 10.10.3 Function of terminal 65

Parameter 70

Parameter 70 = 0: Off.

Parameter 70 = 8: AND with input at terminal 46 (emergency stop).

### 10.10.4 Function of terminal 66

Parameter 71

Parameter 71 = 0: Off.

Parameter 71 = 8: AND with input at terminal 46 (emergency stop).

Parameter 71 = 20: LDS ignition position check.

The BCU does not perform a burner start-up, restart or start-up attempt until the butterfly valve is in ignition position. To ensure that the burners only start with the start-up fuel rate, the FCU issues an enable signal to start the burner via terminal 66 to the BCU with setting P71 = 20. In addition, the safety interlocks must have been enabled by the FCU.

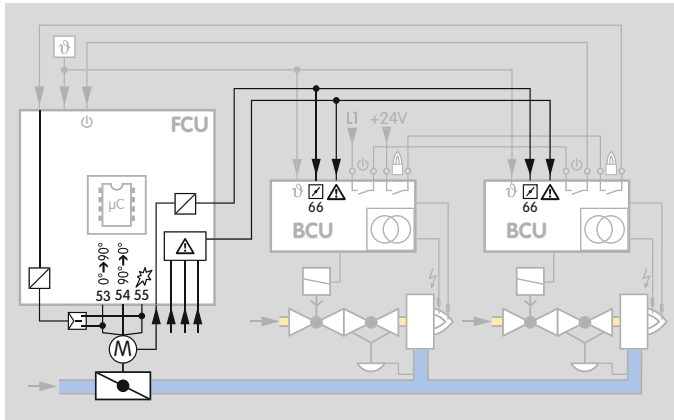

### 10.10.5 Function of terminal 67

Parameter 72

Parameter 72 = 0: Off.

Parameter 72 = 8: AND with input at terminal 46 (emergency stop).

### 10.10.6 Function of terminal 68

Parameter 73

Parameter 73 = 0: Off.

Parameter 73 = 8: AND with input at terminal 46 (emergency stop).

### 10.11 Password

#### Parameter 77

The password is designed to protect the parameter settings. To prevent unauthorized changes to parameter settings, a password is stored in parameter 77 (0000 to 9999). Changes to parameter settings can only be made once this number has been entered. The password can be changed using BCSofT. Note the effect of parameter settings on the safe functioning of your system.

### 10.12 Fieldbus communication

#### Parameter 80

Fieldbus communication can be activated using parameter 80 when bus module BCM 500 is connected.

A device name must be entered in the automation system for the unique identification of the control unit (BCU/FCU) in the Profinet IO system.

Parameter 80 = 0: Off. Parameterization access using BCSofT via Ethernet is still possible.

Parameter 80 = 1: with address check. The device name on delivery for the BCU 580 is “not-assigned-bcu-580-xxx”. The expression “not-assigned-” must be deleted or may be replaced with an individual name. The sequence xxx must be identical to the address set on the BCM 500 using the code switches (xxx = address in the range 001 to FEF).

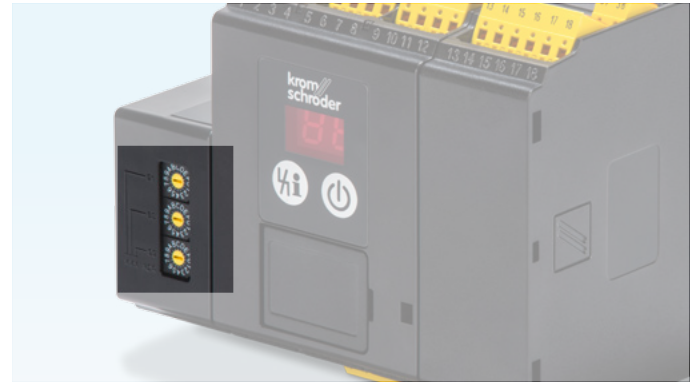

Parameter 80 = 2: no address check. The device name can be selected as specified by the automation system.

## 11 Selection

	Q	W	C0	C1	F1	F2	F3	U0	D0	D1	K0	K1	K2	E
BCU 580	●	●	●	○	●	○	○	○	●	○	○	●	○	●

● = standard, ○ = available

### Order example

BCU 580WC1F1D0K1E

### 11.1 Type code

Code	Description
BCU	Burner control unit
5	Series 500
80	Version for pilot and main burners
Q	Mains voltage: 120 V AC, 50/60 Hz
W	230 V AC, 50/60 Hz
C0	No valve proving system
C1	With valve proving system
F1	Capacity control: interface for actuator IC
F2	interface for RBW actuators
F3	air valve control
U0	Ionization or UV control in case of operation with gas
D0	Digital input: none
D1	for high temperature operation
K0	No plug-in terminals
K1	Plug-in terminals with screw connection
K2	Plug-in terminals with spring force connection
E	Individual packaging

## 12 Project planning information

### 12.1 Installation

Installation position as required.

The BCU mounting is designed for horizontally aligned 35 × 7.5 mm DIN rails.

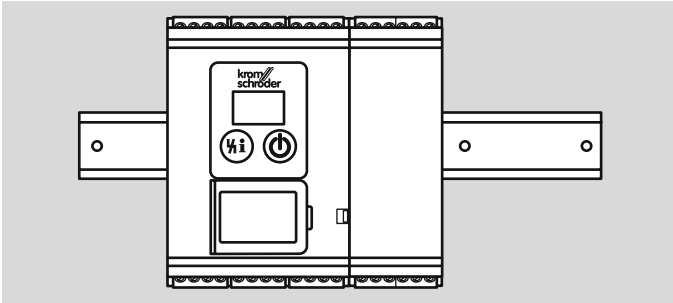

If the DIN rail is aligned vertically, end clamps are required (e.g. Clipfix 35 by Phoenix Contact) to prevent the BCU from slipping.

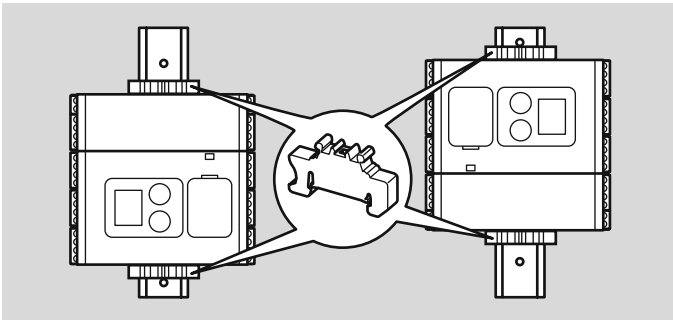

### Environment

Install in a clean environment (e.g. a control cabinet) with an enclosure  $\geq$  IP 54, whereby no condensation is permitted.

### 12.2 Commissioning

Do not start the BCU until the parameter settings and wiring are correct and the faultless processing of all input and output signals complies with the local standards.



## 12.3 Electrical connection

The BCU is designed for connection to a 1-phase system. All inputs and outputs have a one-phase mains supply. Other connected burner control units must use the same phase of the mains supply.

The national standards and safety requirements must be satisfied. If the BCU is operated in ungrounded/IT systems, an insulation monitoring device must be provided to isolate it from the mains in the event of a fault. The cabling of the safety circuits (e.g. pressure switches, gas valves) outside enclosed installation spaces must be protected from mechanical damage and stress (e.g. vibration or bending) as well as short-circuits, short-circuits to ground and cross-circuits.

Signal and control line for screw terminals max.  
2.5 mm<sup>2</sup> (AWG 12), for spring force terminals max.  
1.5 mm<sup>2</sup> (AWG 16).

Do not route BCU cables in the same cable duct as frequency converter cables or cables emitting strong fields.

External electrical interference must be avoided.

### 12.3.1 OCU

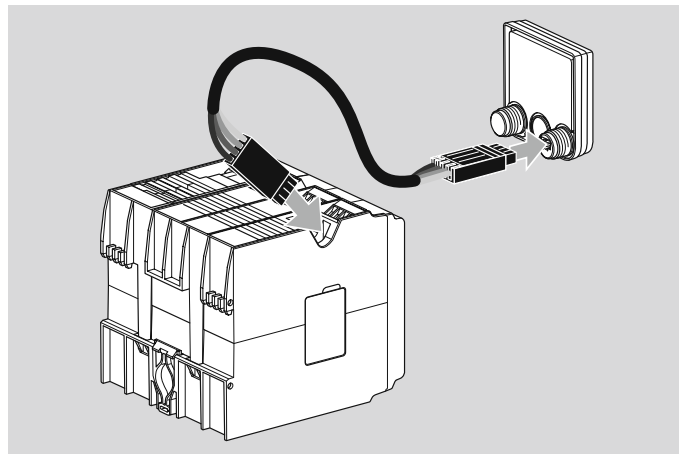

Cables for signalling and telecommunications systems are recommended for wiring the supplied plug connectors:

Cable length max. 10 m, 4-pin,  
min. 0.25 mm<sup>2</sup> (AWG 24),  
max. 0.34 mm<sup>2</sup> (AWG 22).

### 12.3.2 Safety current inputs

Actuation of the safety current inputs only with switch-gear featuring mechanical contacts. If switchgear with semi-conductor contacts is used, the safety current inputs must be connected using relay contacts.

To safeguard the safety current inputs, the fuse must be designed so that the sensor with the lowest switching capacity is protected.

The cabling outside enclosed installation spaces must be protected from mechanical damage and stress (e.g. vibration or bending) as well as short-circuits, short-circuits to ground and cross-circuits.

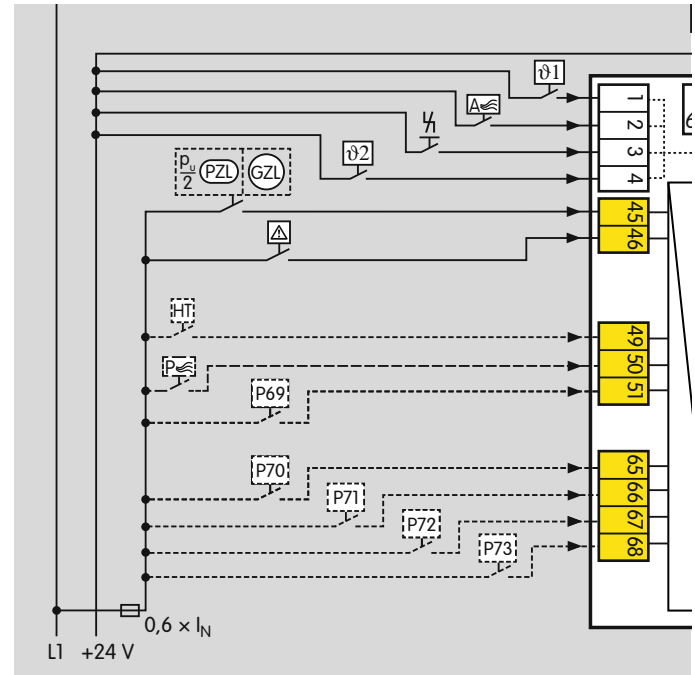

### Calculation

$I_N$  = current of the sensor/contactors with the lowest switching capacity

Suitable fuse =  $0,6 \times I_N$

### 12.3.3 UVD control

An additional voltage supply of 24 V DC is required to operate the UV sensor for continuous operation UVD 1 in conjunction with burner control unit BCU 580. The 24 V DC voltage supply and the 0 – 20 mA current output of the UV sensor must be wired separately.

The 0 – 20 mA current output is not required for normal operation. The 0 – 20 mA current output can only be used to display the flame signal. If it is used for the display in a control room for example, then the cable to the control room must be screened.

Alternating pilot burner (Parameter 79 = 0):

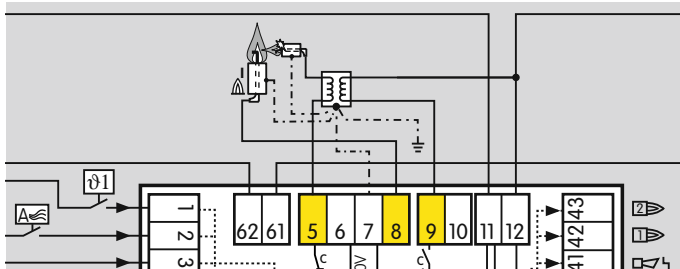

Permanent pilot burner (Parameter 79 = 1):

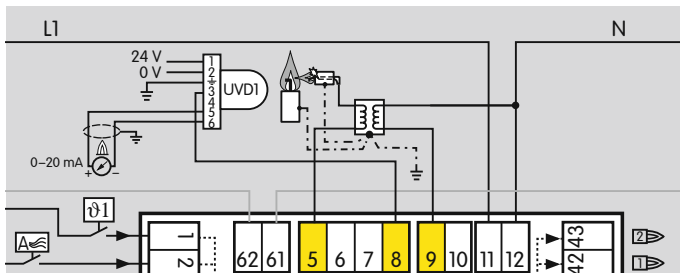

## 12.4 Actuators

If actuators are used, the start gas rate of the burners must be limited for SIL 3 applications in compliance with the standard.

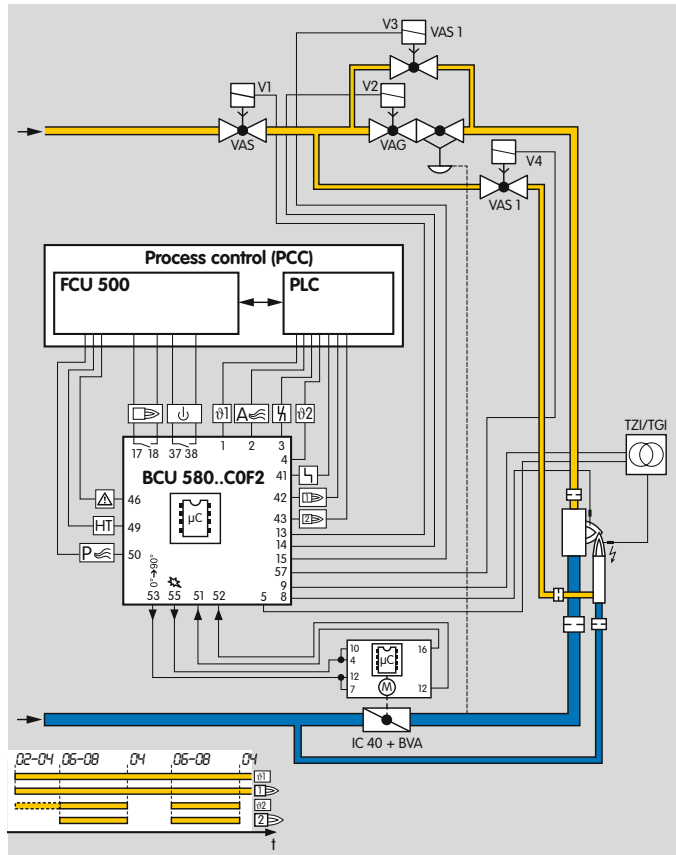

### 12.4.1 IC 20

The BCU..F1 checks the position to which the actuator IC 20 has moved using terminal 52 (feedback) by lifting the signal to terminal 53, 54 or 55, see page 129 (Lifting).

To ensure this check is possible, BCU..F1 and actuator IC 20 or equivalent three-point step actuators must be wired as shown in the connection diagram.

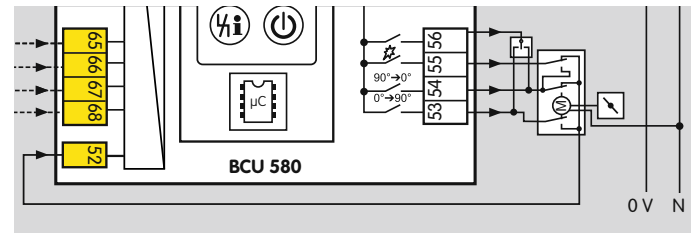

## 12.5 Parameter chip card

The parameter chip card must be installed in the unit for the BCU to operate. The parameter chip card contains the valid parameter settings for the BCU. If a BCU is replaced, the parameter chip card can be removed from the old unit and inserted into the new BCU. The BCU must be disconnected from the electrical power supply for this purpose. The valid parameters are then adopted by the new BCU. The old device and the new BCU must have an identical type code.

## 12.6 Protecting the pilot burner from overload

To protect the unit against overload by frequent cycling, only a specific number of pilot burner start-up attempts can be carried out by the BCU. The maximum number of start-up attempts per minute depends on the safety time  $t_{SA}$  and the ignition time  $t_Z$ .

$t_{SA}$ [s]	$t_Z$ [s]	Cycle lock [s]
3	2	12
5	3	13
10	6	16

If too many start-up attempts are made,  flashes on the display to indicate a fault.

## 12.7 Calculating the safety time $t_{SA}$

Sicherheitszeit im Anlauf  
 $t_{SA}$  nach EN 746-2





D ▼

Brennerart  
Brenner mit Zwangsluft, direkt gezündet ▼

Hauptbrennerleistung PN  kW

Hauptbrenner Sicherheitszeit  s

 Edition 02.12 

## 12.8 Fifth or switchable gas valve on BCU..F3

Units with air valve control have an additional contact (terminal 53/54), which closes at the same time as the air valve.

This can be used to activate a fifth gas valve. To do this, the output of a gas valve must be used as auxiliary energy (e.g. V2 as a result of the required flame control).

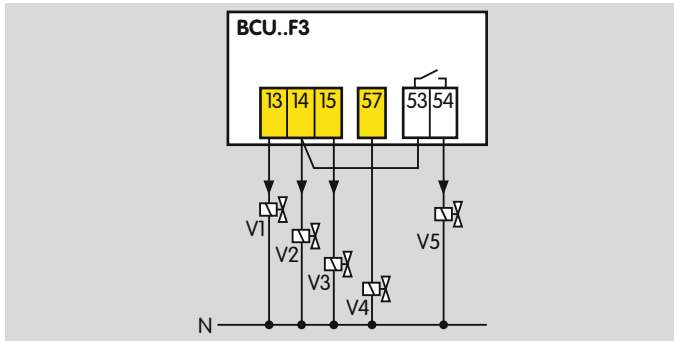

The following application describes a two-stage-controlled burner without a pneumatic air/gas ratio control system. V2 and the air valve are activated simultaneously.

V2 must not be activated during purging.

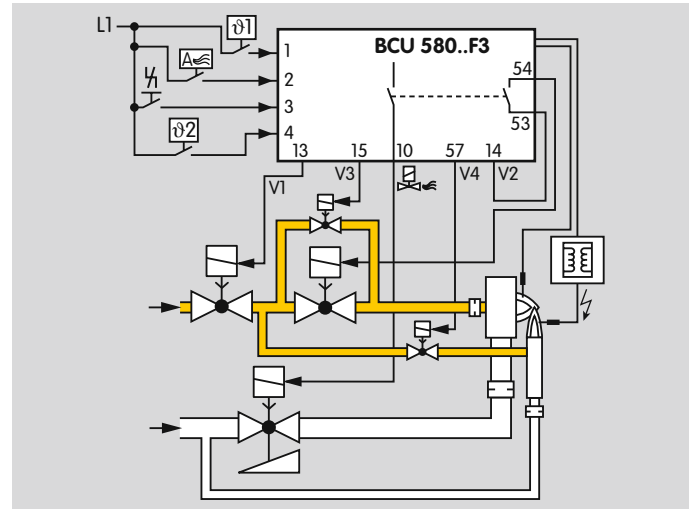

## 13 Accessories

### 13.1 BCSoft

The current software can be downloaded from our Internet site at

[www.docuthek.com](http://www.docuthek.com). To do so, you need to register in the DOCUTHEK.

#### 13.1.1 Opto-adapter PCO 200



Including BCSoft CD-ROM,  
Order No.: 74960625.

#### 13.1.2 Bluetooth adapter PCO 300



Including BCSoft CD-ROM,  
Order No.: 74960617.

### 13.2 OCU



For installation in the control cabinet door in standard grid dimensions. The program step/status or fault messages can be read on the OCU. In Manual mode, the OCU can be used to proceed through the sequence of operating steps.

For details, see from page 114 (OCU).

OCU 500-1, Order No.: 84327030,  
OCU 500-2, Order No.: 84327031.



### 13.3 Connection plug set

For wiring the BCU.

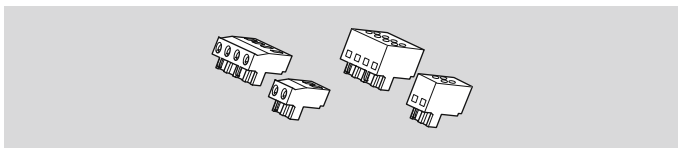

Connection plugs with screw terminals,  
Order No.: 74923997.

Connection plugs with spring force terminals, 2 con-  
nection options per terminal,  
Order No.: 74923999.

### 13.4 Stickers for labelling

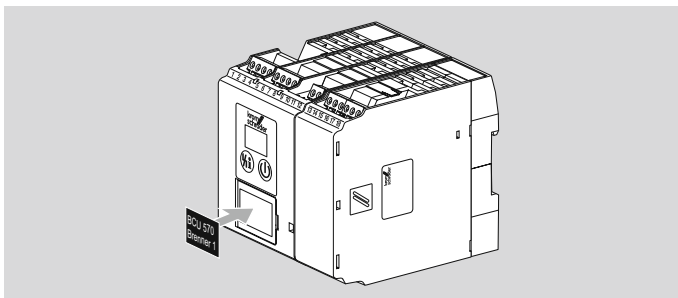

For printing with laser printers, plotters or engraving  
machines, 27 × 18 mm or 28 × 17.5 mm.

Colour: silver.

### 13.5 “Changed parameters” stickers

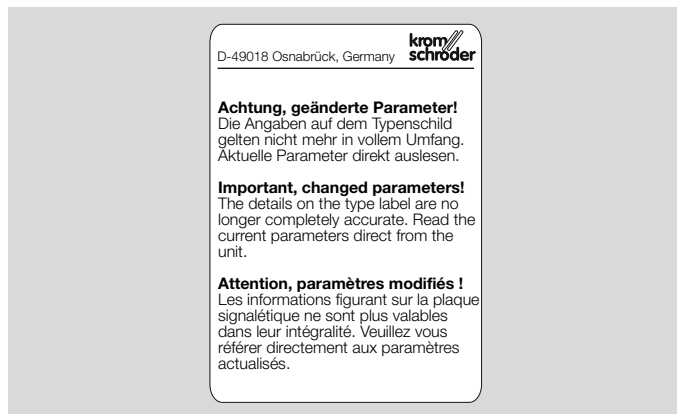

Affix on the BCU following changes to unit parameters  
set at the factory.

100 pcs,

Order No.: 74921492.

## 14 OCU

### 14.1 Application



The OCU is an external operator-control unit which can be connected to a control unit of the FCU 500/BCU 500 series. The external operator-control unit OCU may be installed in the door of a control cabinet, for example. Thus, the control cabinet does not need to be opened to read out process values, statistics, flame signal intensities or parameter values, to change settings on the OCU or to control or adjust connected butterfly valves in Manual mode.

## 14.2 Function



The OCU features an illuminated plain-text display. The lighting is switched on when a control key is pressed and switches off automatically after 5 minutes. In case of a fault lock-out or safety shut-down of the control unit, the OCU light starts blinking.



You can choose between the indicating ranges “status display” and “Service mode”.

The status display shows the program step or a fault message which has occurred in text form with the appropriate code.

The Service mode allows you to read out process values, parameter settings, information on the OCU or the statistics. In addition, you can operate connected control units in Manual mode.

There are five control keys for the OCU and the control unit connected to it:

	<p><b>ON/OFF</b></p> <p>Use the ON/OFF key to switch the control unit on or off.</p>
	<p><b>Reset</b></p> <p>Use the Reset key to reset the control unit to its starting position in the event of a fault.</p>
	<p><b>OK</b></p> <p>Press the OK key to confirm a selection or query. Starting from the status display, you can use the OK key to change to Service mode.</p>

	<p><b>Back</b></p> <p>In Service mode, you can use the Back key to switch from one setting level to the next higher one.</p> <p>By holding down the key for a certain time, you can change directly to the status display.</p>
	<p><b>Navigation UP/DOWN</b></p> <p>In Service mode, the navigation keys can be used to select individual functions on one level.</p> <p>In Manual mode, those keys can be used to open and close an activated butterfly valve.</p>

## 14.2.1 Manual mode

In Manual mode, the control unit works with capacity control (FCU..F1/F2 or BCU..F1/F2) regardless of the status of its inputs. The inputs for start-up signal (terminal 1), controlled air flow (terminal 2) and remote reset (terminal 3) are ignored. The function of the controller enable/emergency stop input (terminal 46) is retained.

The positions for maximum capacity, minimum capacity and ignition capacity of an actuator can be adjusted using the OCU. The OCU supports the process by means of a cyclic, automatic repeat approach to the selected position. The actuator can be moved within the menu to make changes to the cam settings.

After start-up has been completed, the navigation keys can be used, for example, to open or close a butterfly valve in program step 04.

### 14.3 Electrical connection

The OCU is to be connected to the control unit using the two plugs provided.

Required signal and control line:  
 cable length max. 10 m, 4-pin, min. 0.25 mm<sup>2</sup> (AWG 24),  
 max. 0.34 mm<sup>2</sup> (AWG 22).

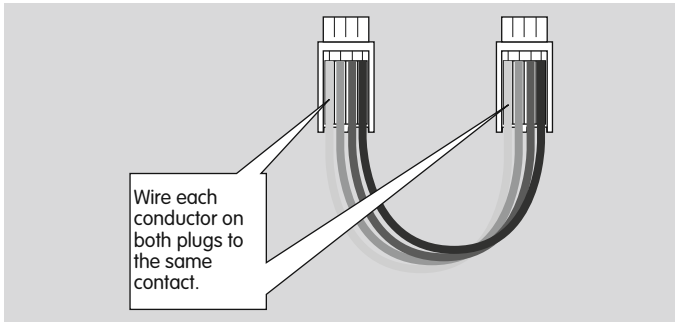
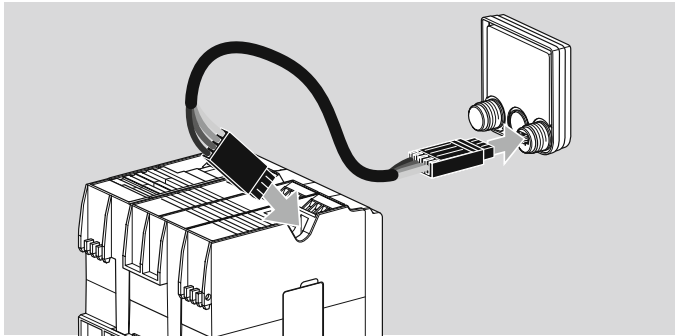

Wire each conductor on both plugs to the same contact.

### 14.4 Installation

The threaded adapters of the OCU are suitable for 23 mm boreholes which are drilled at intervals of 30 mm.

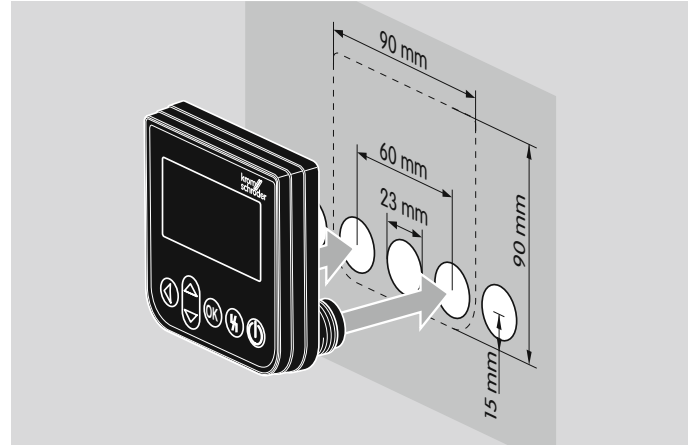

## 14.5 Selection

The OCU can be supplied with various language kits.

Type	Languages	Order No.
OCU 500-1	German, English, French, Dutch, Spanish, Italian	84327030
OCU 500-2	English, Danish, Swedish, Norwegian, Turkish, Portuguese	84327031
OCU 500-3	English, US English, Spanish, Brazilian Portuguese, French	84327032
OCU 500-4	English, Russian, Polish, Croatian, Romanian, Czech	84327033

## 14.6 Technical data for OCU

Ambient temperature: -20 to +60°C.

Relative humidity:

30% to 95% (no condensation permitted).

Enclosure: IP 65 when fitted (control cabinet door).

Dimensions of the operator-control unit: 90 x 90 x 18 mm (W x H x D).

### Electrical connection

Connection data:

wire cross-section flexible min. 0.25 mm<sup>2</sup>,

wire cross-section flexible max. 0.34 mm<sup>2</sup>,

wire cross-section AWG/kcmil min. 24,

wire cross-section AWG/kcmil max. 22,

AWG to UL/CUL min. 24,

AWG to UL/CUL max. 22.

Cable length: inside control cabinet max. 10 m.

## 15 BCM 500

### 15.1 Application



The bus module BCM 500 is used as a communications interface for devices of the BCU/FCU 500 product family for connection to a Profinet network. Networking via Profinet enables the FCU or BCU to be controlled and monitored by an automation system (e.g. PLC).

### 15.2 Function

The bus system transfers the control signals for starting, resetting and for controlling the air valve to purge the furnace or kiln or for cooling in start-up position and heating during operation from the automation system (PLC) to the BCM. In the opposite direction, it sends operating status, the level of the flame signal and the current program step.

### 15.3 Electrical connection

Use only cable and plug components which comply with the appropriate Profinet specifications.

Use shielded RJ45 plugs.

Cable length between 2 Profinet stations: max. 100 m.

Profinet installation guidelines, see [www.profibus.com](http://www.profibus.com).

## 15.4 Installation

Installation position: vertically upright, horizontal or tilted to the left or right.

The BCM mounting is designed for horizontally aligned 35 × 7.5 mm DIN rails.

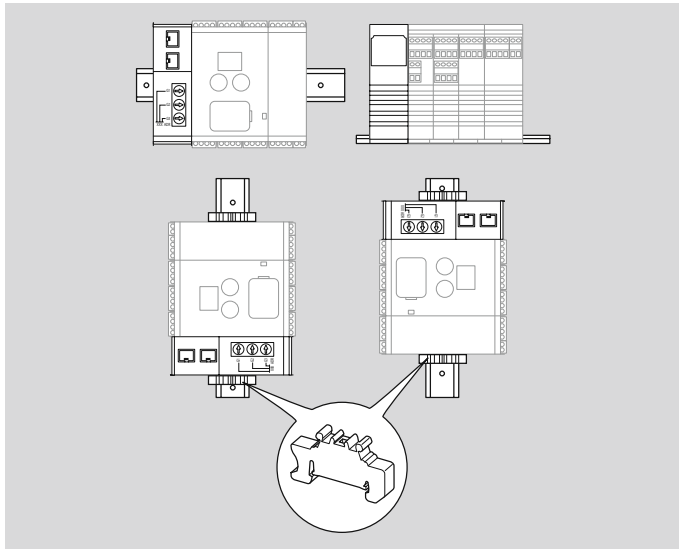

If the DIN rail is aligned vertically, end clamps are required (e.g. Clipfix 35 by Phoenix Contact) to prevent the control unit from slipping.

Install in a clean environment (e.g. a control cabinet) with an enclosure ≥ IP 54, whereby no condensation is permitted.

## 15.5 Selection

Code	Description
BCM	Bus module
500	Series 500
S0	Standard communication
B2	Profinet
/3	Two RJ45 sockets
-3	Three-point step control via bus

Order No.: 74960663

## 15.6 Technical data

### Electrical data

Power consumption: 1.2 VA.

Power loss: 0.7 W.

### Mechanical data

Dimensions (W × H × D):  
32.5 × 115 × 100 mm.

Weight: 0.3 kg.

### Environment

Ambient temperature:  
-20 to +60°C (-4 to +140°F).

Storage temperature:  
-20 to +60°C (-4 to +140°F).

Climate: no condensation permitted.

Enclosure: IP 20 pursuant to IEC 529.

Installation location: min. IP 54 (for installation in a control cabinet).



## 16 Technical data

### 16.1 Electrical data

#### Mains voltage

BCU..Q: 120 V AC, -15/+10%, 50/60 Hz,  $\pm 5\%$ ,  
 BCU..W: 230 V AC, -15/+10%, 50/60 Hz,  $\pm 5\%$ ,  
 for grounded or ungrounded mains.

#### Power consumption

At 230 V AC approx. 6 W/11 VA plus power consumption per AC input of approx. 0.15 W/0.4 VA,  
 at 120 V AC approx. 3 W/5.5 VA plus power consumption per AC input of approx. 0.08 W/0.2 VA.

#### Flame control

With UV sensor or ionization sensor,  
 for continuous operation (intermittent operation with UVS).

Flame signal current: ionization control: 2 – 25  $\mu$ A,  
 UV control: 5 – 25  $\mu$ A.

Signal cable for flame signal current: max. 100 m  
 (164 ft).

#### Contact rating

- Valve outputs V1, V2, V3 and V4 (terminals 13, 14, 15 and 57):  
 max. 1 A each,  $\cos \varphi \geq 0.6$ .
- Actuator outputs (terminals 53, 54 and 55):  
 max. 1 A each,  $\cos \varphi = 1$ .

- Ignition transformer (terminal 9):  
 max. 2 A.
- Total current for the simultaneous activation of the valve outputs (terminals 13, 14, 15 and 57), the actuator (terminals 53 – 56) and the ignition transformer:  
 max. 2.5 A.
- Signalling contact for operating and fault signals:  
 max. 1 A (external fuse required).

#### Number of operating cycles

The fail-safe valve outputs V1, V2, V3 and V4 are monitored for correct functioning and are thus not subject to a max. number of operating cycles.

Actuator (terminals 53, 54 and 55): max. 1,000,000,  
 signalling contact for operating signals: max.  
 1,000,000,

signalling contact for fault signals: max. 10,000,  
 On/Off button: max. 10,000,  
 Reset/Information button: max. 10,000.

Input voltage of signal inputs:

Rated value	120 V AC	230 V AC
Signal "1"	80 – 132 V	160 – 253 V
Signal "0"	0 – 20 V	0 – 40 V

Signal input current:

Signal "1"	max. 5 mA
------------	-----------

Fuses, replaceable,

F1: T 3,15A H,

F2: T 2A H, pursuant to IEC 60127-2/5.

## 16.2 Mechanical data

Weight: 0.7 kg.

### Connections

- Screw terminals:
  - nominal cross-section 0.2 mm<sup>2</sup>,
  - wire cross-section rigid min. 0.2 mm<sup>2</sup>,
  - wire cross-section rigid max. 2.5 mm<sup>2</sup>,
  - wire cross-section AWG/kcmil min. 24,
  - wire cross-section AWG/kcmil max. 12.
- Spring force terminal:
  - nominal cross-section 2 x 1.5 mm<sup>2</sup>,
  - wire cross-section min. 0.2 mm<sup>2</sup>,
  - wire cross-section AWG min. 24,
  - wire cross-section AWG max. 16,
  - wire cross-section max. 1.5 mm<sup>2</sup>,
  - rated current 10 A (8 A UL), to be observed in case of daisy chain.

## 16.3 Environment

Ambient temperature:

- 20 to +60°C (-4 to +140°F),
- no condensation permitted.

Enclosure: IP 20 pursuant to IEC 529.

Installation location: min. IP 54 (for installation in a control cabinet).

## 16.4 Dimensions

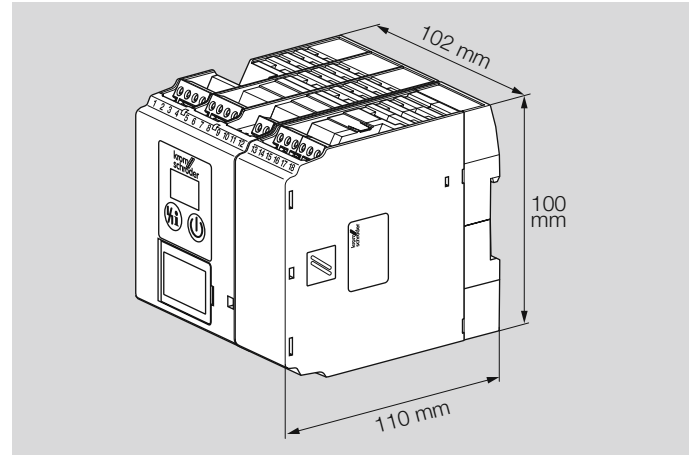

## 16.5 Safety-specific characteristic values

Suitable for Safety Integrity Level	Up to SIL 3
Diagnostic coverage DC	97.2 %
Type of subsystem	Type B to EN 61508-2:2010
Operating mode	High demand mode pursuant to EN 61508-4:2010
Mean probability of dangerous failure PFH <sub>D</sub>	11.5 x 10 <sup>-9</sup> 1/h on BCU 580..F1 11.5 x 10 <sup>-9</sup> 1/h on BCU 580..F2 14.5 x 10 <sup>-9</sup> 1/h on BCU 580..F3
Mean time to dangerous failure MTTF <sub>d</sub>	MTTF <sub>d</sub> = 1/PFH <sub>D</sub>
Safe failure fraction SFF	99.4 %

### Mean probability of dangerous failure PFH<sub>D</sub> of individual safety functions

Valve proving system	5.5 x 10 <sup>-9</sup> 1/h
Safety interlocks	5.5 x 10 <sup>-9</sup> 1/h
Emergency stop with optional input	5.4 x 10 <sup>-9</sup> 1/h
Air flow monitoring	7.2 x 10 <sup>-9</sup> 1/h
Air flow monitoring with optional input	7.1 x 10 <sup>-9</sup> 1/h
Flame control	6.5 x 10 <sup>-9</sup> 1/h
Approaching position for ignition capacity with F1/IC 20	5.6 x 10 <sup>-9</sup> 1/h
Approaching position for ignition capacity with F2/RBW	5.9 x 10 <sup>-9</sup> 1/h
Approaching position for ignition capacity with F3	5.3 x 10 <sup>-9</sup> 1/h

SIL 3 is only achieved in conjunction with actuators IC 20 or RBW if a separate gas valve is used to limit the pilot gas rate, see page 65 (Burner application), parameter 78 = 3.

### Relationship between the Performance Level (PL) and the Safety Integrity Level (SIL)

PL	SIL
a	-
b	1
c	1
d	2
e	3

Pursuant to EN ISO 13849-1:2006, Table 4, the BCU can be used up to PL e.

Max. service life under operating conditions:  
20 years after date of production.

For a glossary of terms, see page 127 (Glossary).

For further information on SIL/PL, see [www.k-sil.de](http://www.k-sil.de)

## **16.6 Converting units**

See [www.adlatus.org](http://www.adlatus.org)

### **17 Maintenance**

The fail-safe outputs (valve outputs V1, V2, V3 and V4) of the power module are monitored for correct functioning. In the event of a fault, the system is set to a safe status using a second shut-down method (isolation of the valve outputs from the mains). In the event of a defect (e.g. fault 36), the power module must be replaced.























See [www.partdetective.de](http://www.partdetective.de)





(optimized for smartphones)

for a replacement/order option for the power module.

The device and user statistics can be displayed using the operator-control unit OCU or engineering tool BC-Soft for further diagnostics and troubleshooting. The user statistics can be reset using engineering tool BC-Soft.

## 18 Legend

	Ready for operation
	Safety interlocks (limits)
	Control element position check
LDS	Safety limits (limits during start-up)
	Gas valve
	Air valve
	Air/gas ratio control valve
	Pilot burner (burner 1)
	Main burner (burner 2)
	Purge
	External air valve control
	Pilot burner flame signal (burner 1)
	Main burner flame signal (burner 2)
	Operating signal, main burner
	Fault signal
	Start-up signal (BCU)
	Input for high temperature operation
	Pressure switch for tightness control (TC)
	Pressure switch for maximum pressure
	Pressure switch for minimum pressure
	Differential pressure switch
	Input signal depending on parameter xx
	Actuator with butterfly valve

TC	Tightness test
$p_u/2$	Half of the inlet pressure
$p_u$	Inlet pressure
$p_d$	Outlet pressure
$V_{p1}$	Test volume
	Valve with proof of closure switch
	Fan
	Three-point step switch
	Emergency stop
	Input/Output, safety circuit
$I_N$	Current consumption of sensor/contactor
$t_L$	Tightness control opening time
$t_M$	Measurement time during tightness test
$t_p$	Tightness control test period (= $2 \times t_L + 2 \times t_M$ )
$t_{FS}$	Flame proving period
$t_{PN}$	Post-purge time
$t_{GV}$	Fan run-up time
$t_E$	Switch-on delay
$t_{SA}$	Safety time on start-up
$t_{VZ}$	Pre-ignition time
$t_{PV}$	Pre-purge time
$t_{RF}$	Controller enable signal delay time

## 19 Glossary

### 19.1 Waiting time $t_W$

In standby, the waiting time  $t_W$  starts to elapse in the background. During the waiting time (display  $HD$ ), a self-test is conducted to detect errors in internal and external circuit components. If no malfunction is detected, the BCU can start the burner.

### 19.2 Ignition time $t_Z$

If no malfunction is detected during the waiting time  $t_W$ , the ignition time  $t_Z$  then starts to elapse. Voltage is supplied to gas valves V1 and V2 as well as to the ignition transformer. The burner is ignited. The duration of the ignition time is either 1, 2, 3 or 6 s (depending on safety time  $t_{SA1}$  selected).

### 19.3 Safety interlocks

The limiters in the safety interlock (linking of all the relevant safety control and switching equipment for the use of the application, e.g. safety temperature limiter, minimum/maximum gas pressure) must isolate input  from the voltage supply.

### 19.4 Safety time on start-up $t_{SA1}$

This refers to the period of time between switching on and switching off of the gas valve, when no flame signal is detected. The safety time on start-up  $t_{SA1}$  (2, 3, 5 or

10 s) is the minimum operating time of the burner and burner control unit.

### 19.5 Safety time during operation $t_{SB}$

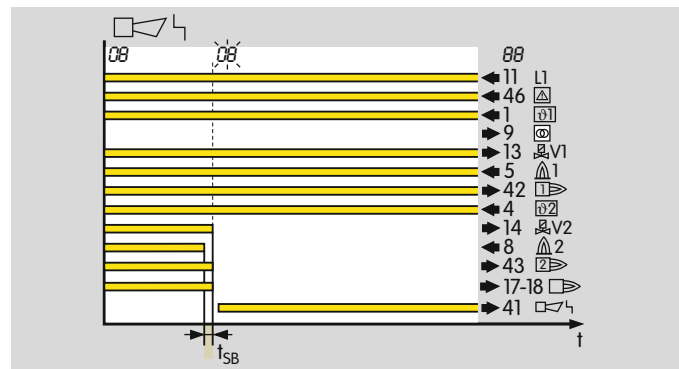

If the flame fails during operation, the output for valve V2 is disconnected within the safety time  $t_{SB}$ .

The default safety time during operation  $t_{SB}$  in accordance with EN 298 is 1 second. In accordance with EN 746-2, the safety time of the installation during operation (including closing time of the valves) may not exceed 3 seconds. Note the requirements of the standards!

### 19.6 Safety shut-down

The burner control unit performs a safety shut-down immediately after receiving a signal from a safety device or after a fault is detected (e.g. flame or air pressure failure). The safety shut-down prevents operation of the burner by closing the fuel shut-off valves and deactivating the ignition device.

For this, the BCU disconnects the gas valves and the ignition transformer from the electrical power supply. The operation signalling contact and the controller enable signal are deactivated. The fault signalling contact remains open. The display blinks and displays the current program step, see page 51 (Fault signalling).

After a safety shut-down, the BCU can restart automatically.

### 19.7 Fault lock-out

A fault lock-out is a safety shut-down with subsequent fault lock-out. The system can only be restarted following manual reset. The protective system cannot be reset by mains failure.

In the event of a fault lock-out of the BCU, the fault signalling contact closes, the display blinks and shows the current program step, see page 51 (Fault signalling). The gas valves are disconnected from the electrical power supply. The fault signalling contact opens if the mains voltage fails.

In order to restart, the BCU can only be reset manually using the button on the front panel, the OCU or the remote reset input (terminal 3).

### 19.8 Warning signal

The BCU reacts to operating faults, e.g. in the case of permanent remote resets, with a warning signal. The display blinks and shows the corresponding warning message. The warning signal ends once the cause has been eliminated.

The program sequence continues. No safety shut-down or fault lock-out occurs.

### 19.9 Timeout

For some process faults, a timeout phase elapses before the BCU reacts to the fault. The phase starts as soon as the BCU detects the process fault and ends after 0 to 255 s. A safety shut-down or fault lock-out is then performed. If the process fault ends during the timeout phase, the process continues as before.



### 19.10 Lifting

After positioning the actuator IC 20, the BCU checks by means of brief lifting whether its feedback input (terminal 52) has been activated by the correct output signal from the actuator. The signal of the relevant control output (ignition, OPEN, CLOSE) is switched off briefly for this purpose. While the signal is switched off, the BCU may not detect a signal at the feedback input.

### 19.11 Air valve

The air valve can be used

- for cooling,
- for purging,
- to control the burner capacity in ON/OFF mode and in High/Low mode when using a pneumatic air/gas ratio control system.

### 19.12 Diagnostic coverage DC

Measure of the effectiveness of diagnostics, which may be determined as the ratio between the failure rate of detected dangerous failures and the failure rate of total dangerous failures

NOTE: Diagnostic coverage can exist for the whole or parts of a safety-related system. For example, diagnostic coverage could exist for sensors and/or automation system and/or control elements. Unit: %.

*from EN ISO 13849-1:2008*

### 19.13 Operating mode

IEC 61508 describes two modes of operation for safety functions. These are low demand mode and high demand or continuous mode.

In low demand mode, the frequency of demands for operation made on a safety-related system is not greater than one per year and is not greater than twice the proof-test frequency. In high demand mode or continuous mode, the frequency of demands for operation made on a safety-related system is greater than one per year or greater than twice the proof-test frequency.

*See also IEC 61508-4*

### **19.14 Safe failure fraction SFF**

Fraction of safe failures related to all failures, which are assumed to appear

*from EN 13611/A2:2011*

### **19.15 Probability of dangerous failure $\text{PFH}_D$**

Value describing the likelihood of dangerous failure per hour of a component for high demand mode or continuous mode. Unit: 1/h.

*from EN 13611/A2:2011*

### **19.16 Mean time to dangerous failure $\text{MTTF}_d$**

Expectation of the mean time to dangerous failure

*from EN ISO 13849-1:2008*

## Feedback

Finally, we are offering you the opportunity to assess this “Technical Information (TI)” and to give us your opinion, so that we can improve our documents further and suit them to your needs.

### Clarity

- Found information quickly
- Searched for a long time
- Didn't find information
- What is missing?
- No answer

### Comprehension

- Coherent
- Too complicated
- No answer

### Scope

- Too little
- Sufficient
- Too wide
- No answer



### Use

- To get to know the product
- To choose a product
- Planning
- To look for information

### Navigation

- I can find my way around
- I got “lost”
- No answer

### My scope of functions

- Technical department
- Sales
- No answer

### Remarks

## Contact

Elster GmbH  
Postfach 2809 · 49018 Osnabrück  
Strothweg 1 · 49504 Lotte (Büren)  
Germany

Tel +49 541 1214-0  
Fax +49 541 1214-370  
info@kromschroeder.com  
www.kromschroeder.com

The current addresses of our international agents are available on the Internet:  
[www.kromschroeder.de/Weltweit.20.0.html?&L=1](http://www.kromschroeder.de/Weltweit.20.0.html?&L=1)

We reserve the right to make technical modifications in the interests of progress.  
Copyright © 2016 Elster GmbH  
All rights reserved.

